

RUUKKI GAMINIŲ KAINORAŠTIS

Galioja nuo 2024 04 15



Turinys

Kokybės klasės	3	Paslėptoji lietaus nuvedimo sistema	28–30
Stogo dangos	4–7	Stogo saugos elementai	31–33
Stogo lankstiniai Classic profiliams	8–10	Vielinio lyno sistema Ruukki Safeline	34
Stogo lankstiniai čerpiniams ir profiliuotiems lakštams	11–14	Profiluoti lakštai	35–36
Stogo lankstiniai Classic profiliams	15–10	Stogo pakalimai	37
Sraigčiai, plėvelės, sandarinimo juostos	20–21	Lygi skarda	38
Dažai, kaminėliai, įvadai	22–23	Classic profilių palyginimo lentelė	39
Lietaus vandens nuvedimo sistemos	24–27		

Ruukki kokybės klasės – tai ne vien produkto charakteristikos

Ruukki kokybės klasė – tai ne tik produkto originalumo, kokybės ir ilgamžiškumo ženklas. Tai – ilgamečio rinkos lyderio pažadas, kad stogo įsigijimas vyks užtikrinant aukščiausią aptarnavimo kokybę, projektavimo ir tiekimo sklandumą. Mūsų gaminių asortimentas yra labai didelis, todėl tikimės, kad jums pavyks rasti norimą sprendimą savo stogui.

- ● ● ● ● puiki
- ● ● ● ○ labai gera
- ● ● ○ ○ gera
- ● ○ ○ ○ patenkinama



Kokybės klasė	Ruukki® 50 Plus	Ruukki® 40	Ruukki® 30 Plus	Ruukki® 30
Polimerinė danga	GreenCoat Pural BT Matt	GreenCoat Crown BT	Rough Matt Polyester	Polyester
Polimerinės dangos paviršius	Struktūriškas	Smulkios struktūros	Struktūriškas	Lygus
Išvaizda	Matinė	Pusiau matinė	Matinė	Blizgi
Nominalus polimerinės dangos storis (µm)	50	26	30	25
Atsparumas UV spinduliotei	● ● ● ● ● Ruv5	● ● ● ● ○ Ruv3	● ● ● ● ○ Ruv3	● ● ○ ○ ○ Ruv2
Atsparumas korozijai	● ● ● ● ● RC5+	● ● ● ● ○ RC4	● ● ● ● ○ RC4	● ● ● ○ ○ RC3
Atsparumas įbrėžimams	● ● ● ● ● ≥ 4,000 g	● ● ● ● ○ ≥ 2,500 g	● ● ● ● ○ ≥ 2,500 g	● ● ● ○ ○ ≥ 2,000 g
Minimalus leistinas lenkimas	● ● ● ● ● 1T	● ● ● ● ● 1T	● ● ● ○ ○ 2T	● ● ○ ○ ○ 3T
Techninė garantija	50 metų	40 metų	30 metų	30 metų
Estetinė garantija	25 metai	15 metų	10 metų	10 metų

* Ruv5 ir RC5+ yra naujos, 2022 m. atnaujintuose standartuose EN 10169:2022 aprašytos, aukščiausios galimos atsparumo korozijai ir UV spinduliotei kategorijos. RC5+ ir Ruv5 kategorijas atitinkantys gaminiai turi būti išsamiai ištestuoti natūraliomis C5 poveikio aplinkos sąlygomis (ne laboratorijoje) ne trumpesni nei ketverių metų laikotarpį, bei išlikti atsparūs pūslių susidarymui, polimerinės dangos paviršiaus pažeidimams, briaunų lupimuisi daugiau nei 2 mm, maksimaliai ilgai išlaikyti spalvą ir blizgesį.

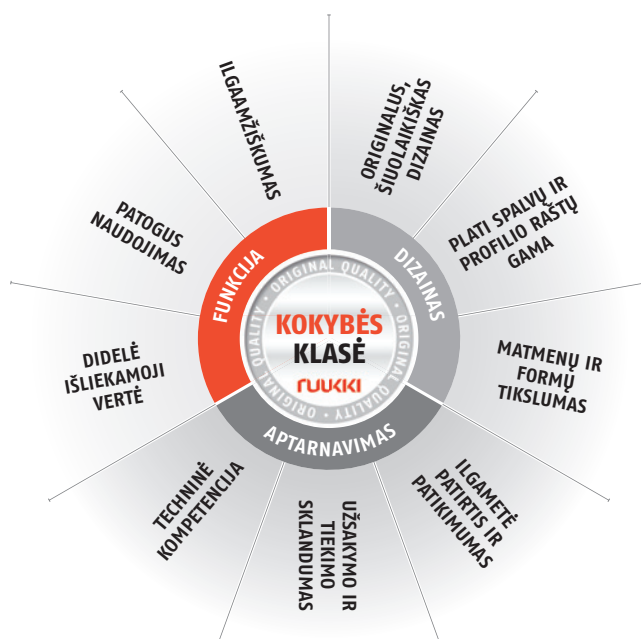

Ruukki stogo dangų kainos

Kainos nurodytos už kvadratinį metrą

Classic profiliai

Kaina €/m² su PVM 21% (€/m² be PVM)

Pavadinimas	Ruukki® 50 Plus Matt	Ruukki® 30 Plus Matt	Silence (su veltiniu) *
Classic NextGen SR35-475CF	46,22 (38,20)		
Classic Design C 271 mm NAUJIENA	38,96 (32,20)		
Classic Design C 355 mm NAUJIENA	34,00 (28,10)		
Classic Design C 475 mm NAUJIENA	31,58 (26,10)		
Classic Authentic 0.6 mm SR35-475C/D	31,16 (25,75)		37,11 (30,67)
Classic M SR35-475M	26,26 (21,70)		32,21 (26,62)
Classic SR35-475C/D	25,65 (21,20)		31,61 (26,12)
Classic Economy Plus SR35-475C/D		16,46 (13,60)	22,41 (18,52)

Valcuoti lakštai

Kaina €/m² su PVM 21% (€/m² be PVM)

Pavadinimas	Ruukki® 50 Plus Matt	Ruukki® 30 Plus Matt	Ruukki® 30
Valcuoti lakštai SR27-543A/B	22,51 (18,60)		

* **Silence** – vidinėje Classic lakšto pusėje priklijuotas specialus, Dripstop Soundcontrol veltinis.

Classic Silence privalumai

- Apie 40% geresnės akustinės savybės (-6dB)
- Degumo klasė B2 – s1, d0
- Sugeria iki 2500 g/m² kondensato

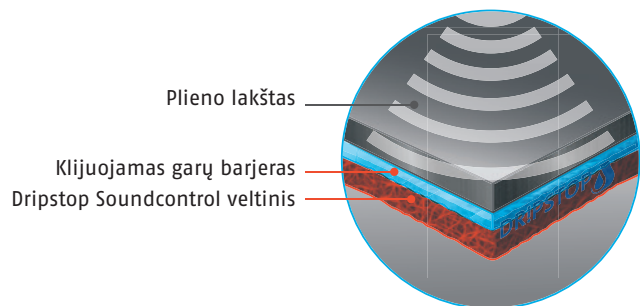

Čerpiniai profiliai

Kaina €/m² su PVM 21% (€/m² be PVM)

Pavadinimas	Ruukki® 50 Plus Matt	Ruukki® 40	Ruukki® 30 Plus Matt	Ruukki® 30
Adamante TS55-350-1130	23,35 (19,30)		16,09 (13,30)	14,76 (12,20)
Monterrey FEB Forma® TS44-350-1100	21,72 (17,95)	19,72 (16,30)		
Monterrey TS39-350-1100			15,43 (12,75)	13,49 (11,15)
Monterrey Eco 0.45 mm TS39-350-1100				12,52 (10,35)

Moduliniai profiliai

Kaina €/vnt. su PVM 21% (€/vnt. be PVM)

Pavadinimas	Ruukki® 50 Plus Matt	Ruukki® 40	Ruukki® 30 Plus Matt	Ruukki® 30
Hyygge V*		10,95 (9,05)		
Frigge**	19,66 (16,25)	16,82 (13,90)	16,34 (13,50)	15,67 (12,95)
Finnera*** TS52-330-1140		14,35 (11,86)		

* Hyygge 1 lakšto naudingas plotas yra 0,341 m², kiekis paletėje – 180 vnt. Užsakoma pakuotėmis po 9 vienetus.

** Frigge 1 lakšto naudingas plotas yra 0,83 m², kiekis paletėje – 200 vnt. Už kiekį, mažesnę nei 60 vnt., taikomas startinis 30,25 (25,00) eurų startinis mokestis.

*** Finnera 1 lakšto naudingas plotas yra 0,75 m², kiekis paletėje – 310 vnt.

Montuojant Ruukki 50, Ruukki 30 Plus ir Ruukki 30 kokybės klasių modulinius lakštus – nerekomenduojama naudoti skirtingų partijų gaminius.

Profiliuoti lakštai

Kaina €/m² su PVM 21% (€/m² be PVM)

Pavadinimas	Ruukki® 50 Plus Matt	Ruukki® 40	Ruukki® 30 Plus Matt	Ruukki® 30
T20 T20-24W-1100	21,18 (17,50)	18,39 (15,20)	14,40 (11,90)	13,07 (10,80)
T20 su antikondensaciniu veltiniu **** T20-24W-1100	27,13 (22,42)	24,34 (20,12)	20,35 (16,82)	19,02 (15,72)

Profilių užsakymams mažesniems nei 20 m² taikomas 36,30 (30,00) eurų startinis mokestis.

Profiliams, ilgesniems nei 6 tiesiniai metrai, reikalingas medinis padėklas. Padėklo kaina – 12,10 (10,00) eurai už tiesinį metrą.

Visą profiliuotų (trapecinių) lakštų asortimentą žr. 40–41 psl.

****** Antikondensacinis sluoksnis** – vidinėje T20, T45 lakštų pusėje priklijuotas specialus, Dripstop Original veltinis.

DripStop privalumai

- Geresnės akustinės savybės (-2dB)
- Degumo klasė A2 - s1, d0
- Sugeria iki 1000 g/m² kondensato

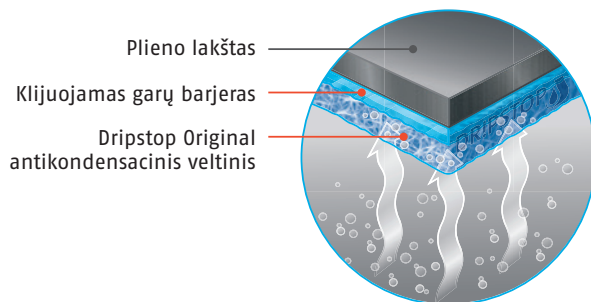
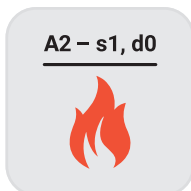

Classic profiliai

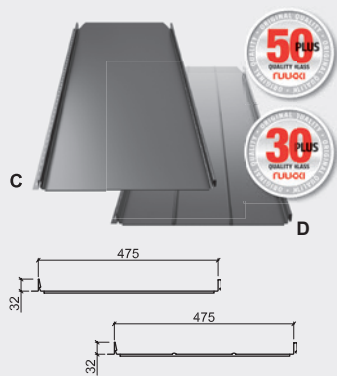

CLASSIC C, D **

Profilio aukštis	32 mm
Naudingas dengiamas plotis	475 mm
Bendras plotis	510 mm
Maksimalus naudingas ilgis	12 500 mm
Minimalus naudingas ilgis	1 200 mm
Minimalus stogo nuolydis	7°*
Lakšto storis	0.50 mm
Cinko kiekis	275 g/m ²
Svoris	5.2 kg/m ²

- ✓ Galimybė užsakyti Silence versiją
- ✓ Priekinio krašto užlenkimas
- ✓ Uždengiami valcų galai
- ✓ Mikroprofiluota tvirtinimo linija
- ✓ Bet kuri montavimo kryptis

** Classic Economy Plus C / D – Ruukki 30 Plus kokybės klasės

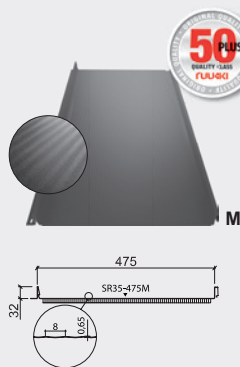

CLASSIC M

Profilio aukštis	32 mm
Naudingas plotis	475 mm
Bendras plotis	510 mm
Maksimalus naudingas ilgis	12 500 mm
Minimalus naudingas ilgis	1 200 mm
Min. stogo nuolydis	7°*
Lakšto storis	0.50 mm
Cinko kiekis	275 g/m ²
Svoris	5.2 kg/m ²

- ✓ Galimybė užsakyti Silence versiją
- ✓ Priekinio krašto užlenkimas
- ✓ Uždengiami valcų galai
- ✓ Mikroprofiluota tvirtinimo linija
- ✓ Mikroprofiluotas lakštas
- ✓ Bet kuri montavimo kryptis

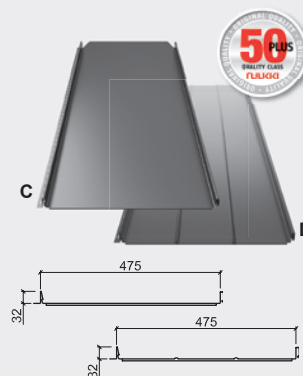

CLASSIC AUTHENTIC C, D

Profilio aukštis	32 mm
Naudingas dengiamas plotis	475 mm
Bendras plotis	510 mm
Maksimalus naudingas ilgis	12 500 mm
Minimalus naudingas ilgis	1 200 mm
Minimalus stogo nuolydis	7°*
Lakšto storis	0.60 mm
Cinko kiekis	275 g/m ²
Svoris	6.2 kg/m ²

- ✓ Galimybė užsakyti Silence versiją
- ✓ Priekinio krašto užlenkimas
- ✓ Uždengiami valcų galai
- ✓ Mikroprofiluota tvirtinimo linija
- ✓ Bet kuri montavimo kryptis

Valcuoti lakštai



CLASSIC NEXTGEN

Profilio aukštis	33 mm
Naudingas dengiamas plotis	475 mm
Bendras plotis	510 mm
Maksimalus naudingas ilgis	12 500 mm
Minimalus naudingas ilgis	800 mm
Minimalus stogo nuolydis	7°*
Lakšto storis	0.60 mm
Cinko kiekis	275 g/m ²
Svoris	6.4 kg/m ²

- ✓ Sujungimų sandarumą ir akustines savybes pagerinanti valco tarpinė
- ✓ Akustinis/antikondensacinis veltinis
- ✓ Uždengiami valcų galai
- ✓ Priekinio krašto užlenkimas
- ✓ Mikroprofiluota tvirtinimo linija

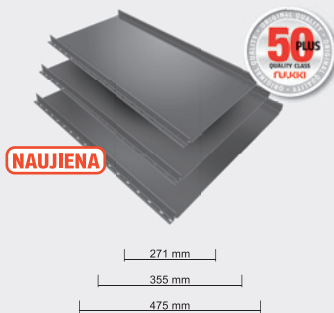

CLASSIC DESIGN C 271/355/475 mm

Profilio aukštis	32 mm
Naudingas dengiamas plotis	475 mm, 355 mm, 271 mm
Bendras plotis	510 mm, 390 mm, 300 mm
Maksimalus ilgis	10 000 mm
Minimalus ilgis	1 200 mm
Minimalus stogo nuolydis	7°*
Lakšto storis	0.60 mm
Cinko kiekis	275 g/m ²
Svoris	6.2, 6.7, 7.4 kg/m ²

- ✓ Priekinio krašto užlenkimas, uždengiami valcų galai, mikroprofiluota tvirtinimo linija
- ✓ Naujiena: Neribotos raštų pasirinkimo galimybės derinant 3 pločius ir 3 spalvas



VALCUOTI LAKŠTAI

Profilio aukštis	27 mm
Naudingas dengiamas plotis	543 mm
Maksimalus naudingas ilgis	10 000 mm
Minimalus naudingas ilgis	1 100 mm
Minimalus stogo nuolydis	7°
Lakšto storis	0.50 mm
Cinko kiekis	275 g/m ²
Svoris	4.5 kg/m ²



Pasirinkus Classic Silence (su veltiniu):

- apie 40% geresnės akustinės savybės (-6dB)
- mažiau kondensato
- gamyklinis, patikimas sprendimas

* 7° nuolydis galioja, kai lakštai nejungiami į ilgį. Jei lakštai jungiami, minimalus nuolydis 14°.

Bendrą Classic profilių savybių palyginimo lentelę žiūrėti 39 psl.



Čerpiniai profiliai

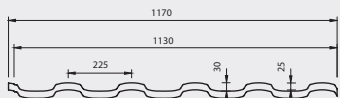
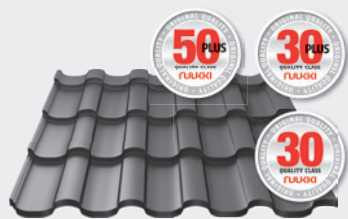

ADAMANTE

Profilio aukštis	55 mm
Bangos ilgis	350 mm
Naudingas dengiamas plotis	1130 mm
Bendras plotis	1170 mm
Maksimalus ilgis	8 200 mm
Minimalus ilgis	800 mm
Minimalus stogo nuolydis	14°
Lakšto storis	0.50 mm
Cinko kiekis	275 g/m ²
Svoris	4.8 kg/m ²

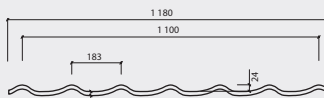

MONTERREY FEB FORMA®

Profilio aukštis	44 mm
Bangos ilgis	350 mm
Naudingas dengiamas plotis	1100 mm
Bendras plotis	1180 mm
Maksimalus ilgis	8 000 mm
Minimalus ilgis	800 mm
Minimalus stogo nuolydis	14°
Lakšto storis	0.50 mm
Cinko kiekis	275 g/m ²
Svoris	4.7 kg/m ²

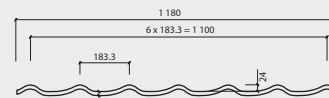

MONTERREY ECO, MONTERREY

Profilio aukštis	39 mm
Bangos ilgis	350 mm
Naudingas dengiamas plotis	1100 mm
Bendras plotis	1180 mm
Maksimalus ilgis	8 000 mm
Minimalus ilgis	800 mm
Minimalus stogo nuolydis	14°
Lakšto storis	0.45, 0.50 mm
Cinko kiekis	275 g/m ²
Svoris	4.1, 4.5 kg/m ²

Ruukki Monterrey FEB forma® užlenktas kraštas – gražesnė forma, korozijai atsparesnis, ilgaamžiškesnis stogas.



Moduliniai profiliai

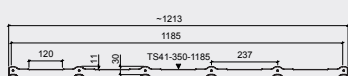

FRIGGE

Profilio aukštis	41 mm
Bangos ilgis	350 mm
Naudingas plotis	1185 mm
Bendras plotis	1 213 mm
Naudingas ilgis	700 mm
Bendras ilgis	720 mm
Min. stogo nuolydis	14°
Lakšto storis	0.50 mm
Cinko kiekis	275 g/m ²
Svoris	4.3 kg/m ²
Lakšto svoris	3.5 kg/vnt.

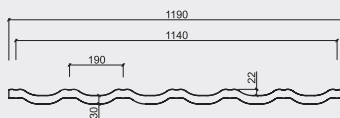

FINNERA

Profilio aukštis	52 mm
Bangos ilgis	330 mm
Naudingas dengiamas plotis	1140 mm
Bendras plotis	1190 mm
Naudingas ilgis	660 mm
Bendras ilgis	708 mm
Minimalus stogo nuolydis	14°
Lakšto storis	0.50 mm
Cinko kiekis	275 g/m ²
Svoris	5.0 kg/m ²
Vieno lakšto svoris	3.8 kg/vnt.

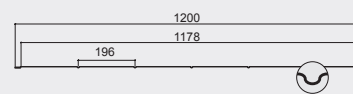
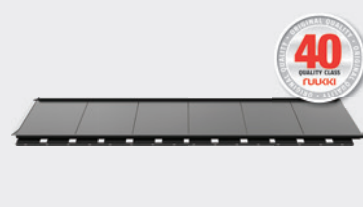

HYYGGE V

Profilio aukštis	26 mm
Bangos ilgis	290 mm
Naudingas dengiamas plotis	1178 mm
Bendras plotis	1 200 mm
Naudingas ilgis	290 mm
Bendras ilgis	343 mm
Minimalus stogo nuolydis	14°
Lakšto storis	0.60 mm
Cinko kiekis	275 g/m ²
Svoris	7.0 kg/m ²
Vieno lakšto svoris	2.35 kg/vnt.

Profliuotų (trapecinių) lakštų stogams ir sienoms duomenis žr. 35 psl.

Ruukki padengimų spalvos

	Kokybės klasė 	Paviršius	Raudonos plytos RR 750	Raudona RR 29	Šokoladinė RR 887	Tamsi ruda RR 32	Tamsi žalia RR 11	Šviesi pilka RR 21	Pilka RR 22	Tamsi pilka RR 23	Antracito RR2H3	Juoda RR 33
--	--	-----------	---------------------------	------------------	----------------------	---------------------	----------------------	-----------------------	----------------	----------------------	--------------------	----------------

Classic profiliai

Classic NextGen	Ruukki® 50 Plus	matinis	•	•		•	•	•	•	•	•	•
Classic Design C	Ruukki® 50 Plus	matinis								•	•	•
Classic Authentic	Ruukki® 50 Plus	matinis				•				•	•	•
Classic M	Ruukki® 50 Plus	matinis	•	•	•	•	•		•	•	•	•
Classic	Ruukki® 50 Plus	matinis	•	•	•	•	•		•	•	•	•
Classic Economy Plus	Ruukki® 30 Plus	matinis		•	•	•				•	•	•

Valcuoti lakštai

Valcuoti lakštai	Ruukki® 50 Plus	matinis	•	•	•	•	•		•	•	•	•
------------------	-----------------	---------	---	---	---	---	---	--	---	---	---	---

Čerpiniai profiliai

Adamante	Ruukki® 50 Plus	matinis	•	•	•	•	•			•	•	•
Adamante	Ruukki® 30 Plus	matinis		•	•	•				•	•	•
Adamante	Ruukki® 30	blizgus	•	•	•	•	•			•	•	•
Monterrey FEB forma®	Ruukki® 50 Plus	matinis	•	•	•	•	•			•	•	•
Monterrey FEB forma®	Ruukki® 40	pusiau matinis		•	•	•				•	•	•
Monterrey	Ruukki® 30 Plus	matinis		•	•	•				•	•	•
Monterrey	Ruukki® 30	blizgus	•	•	•	•	•			•	•	•
Monterrey Eco	Ruukki® 30	blizgus				•				•		

Moduliniai lakštai

Hyygge V	Ruukki® 40	pusiau matinis								•	•	•
Frigge	Ruukki® 50 Plus	matinis	•	•	•	•				•	•	•
Frigge	Ruukki® 40	pusiau matinis	•	•	•	•				•	•	•
Frigge	Ruukki® 30 Plus	matinis	•	•	•	•				•	•	•
Frigge	Ruukki® 30	blizgus	•	•	•	•				•	•	•
Finnera	Ruukki® 40	pusiau matinis	•	•	•	•				•	•	•

Profiliuoti lakštai

T20	Ruukki® 50 Plus	matinis	•	•	•	•	•	•	•	•	•	•
T20	Ruukki® 40	pusiau matinis		•	•	•				•	•	•
T20	Ruukki® 30	blizgus	•	•	•	•	•	•	•	•	•	•

* Kitų spalvų ir padengimų kainų teirautis pas pardavėją.

Standartiniai stogo lankstiniai Classic profilams

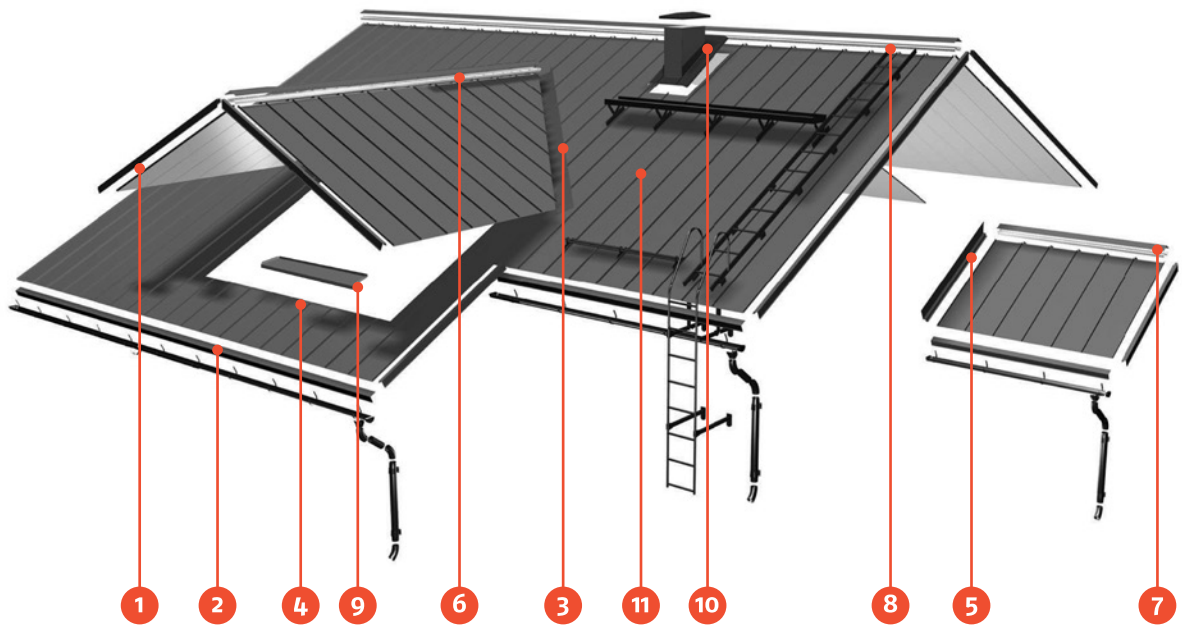











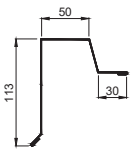

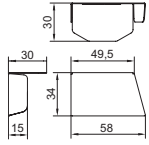
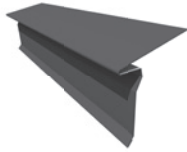
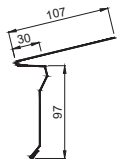
- 1 Vėjalentė
- 2 Karnizas
- 3 Apatinė sąlaja
- 4 Vidinis kampas

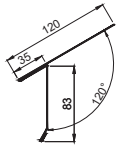
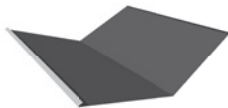
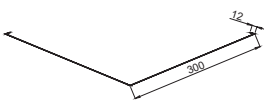
- 5 Šoninis jungimas prie sienos
- 6 Kraigas
- 7 Vienšlaitis kraigas
- 8 Kraigo vėdinimo detalė

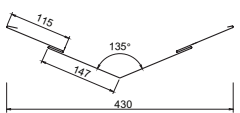
- 9 Palangės, angokraščiai
- 10 Kamino lankstiniai
- 11 Lakštų jungimo elementas

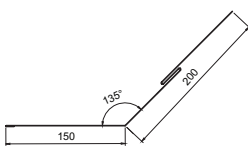

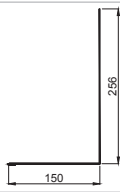
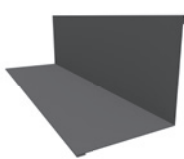
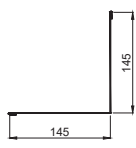

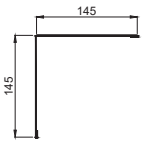



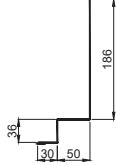

Lankstiniai ir priedai

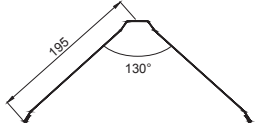
Kaina €/vnt. su PVM 21% (€/vnt. be PVM)

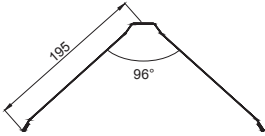
Vaizdas	Brėžinys	Pavadinimas	Kodas	Kokybės klasė	Kaina
		Classic vėjalentė L = 2000 mm	RA9AG	Ruukki® 50 Plus Matt Ruukki® 30 Plus Matt	25,35 (20,95) 23,11 (19,10)
NAUJIENA 		Classic vėjalentės antgalis Komplektas (kairinis + dešininis)		Ruukki® 50 Plus Matt (Tik RR23, RR2H3, RR32 ir RR33 spalvos)	7,86 (6,50)
		Classic karnizo lenta L = 2000 mm	RA9AEF	Ruukki® 50 Plus Matt	20,33 (16,80)
		Classic karnizo lenta L = 2000 mm	RA1AE	Ruukki® 50 Plus Matt Ruukki® 30 Plus Matt	20,33 (16,80) 17,55 (14,50)
		Classic apatinė sąlaja 625 L = 2000 mm	625RA1BV	Ruukki® 50 Plus Matt Ruukki® 30 Plus Matt	49,25 (40,70) 42,11 (34,80)
NAUJIENA 		Classic apatinė sąlaja L = 2000 mm	305000125	Ruukki® 50 Plus Matt Ruukki® 30 Plus Matt	49,25 (40,70) 42,11 (34,80)
NAUJIENA 		Classic šlaito sujungimas L = 2000 mm	305000039	Ruukki® 50 Plus Matt Ruukki® 30 Plus Matt	39,57 (32,70) 30,73 (25,40)
		Vidinis kampas L = 2000 mm	RA1BJ	Ruukki® 50 Plus Matt Ruukki® 30 Plus Matt	39,57 (32,70) 30,73 (25,40)
		Vidinis kampas L = 2000 mm	RA1CI	Ruukki® 50 Plus Matt (išskyrus RR887) Ruukki® 30 Plus Matt (išskyrus RR887, RR2H3)	26,56 (21,95) 25,35 (20,95)
		Išorinis kampas L = 2000 mm	RA1CE	Ruukki® 50 Plus Matt Ruukki® 30 Plus Matt (išskyrus RR887, RR2H3)	26,56 (21,95) 25,35 (20,95)

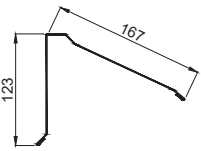
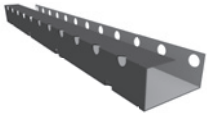
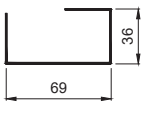
Lankstiniai ir priedai

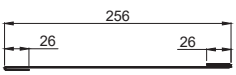
Kaina €/vnt. su PVM 21% (€/vnt. be PVM)





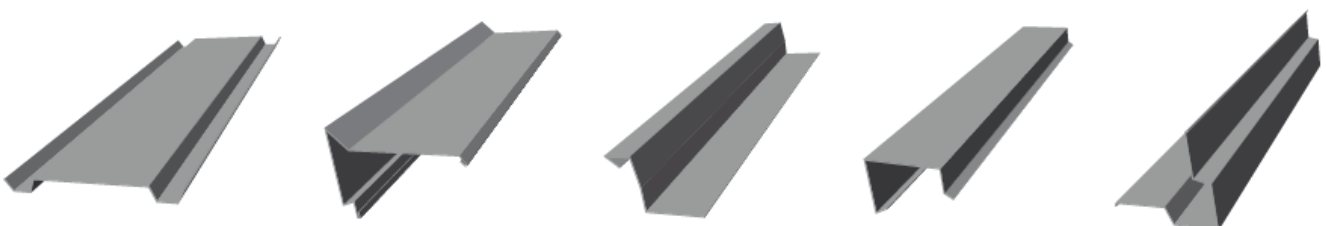

Vaizdas	Brėžinys	Pavadinimas	Kodas	Kokybės klasė	Kaina
		Classic šoninis jungimas prie sienos L = 2000 mm	RA1AJD	Ruukki® 50 Plus Matt Ruukki® 30 Plus Matt	26,56 (21,95) 25,35 (20,95)
		Classic kraigas L = 2000 mm	RA9AR	Ruukki® 50 Plus Matt (išskyrus RR887, RR2H3) Ruukki® 30 Plus Matt	25,35 (20,95) 23,11 (19,10)
		Classic kraigas L = 2000 mm	RA1AR	Ruukki® 50 Plus Matt (tik RR887, RR2H3) Ruukki® 30 Plus Matt	25,35 (20,95) 23,11 (19,10)
		Kraigas vienslaičiam stogui L = 2000 mm	RA1AEU	Ruukki® 50 Plus Matt Ruukki® 30 Plus Matt	28,31 (23,40) 27,77 (22,95)
		Classic kraigo vėdinimo detalė	RA1AS460 RA1AH3000	Ruukki® 50 Plus Matt L = 460 mm (pritaikyta Ruukki® Classic lakštams) Ruukki® 50 Plus Matt L = 3000 mm	3,51 (2,90) 19,97 (16,50)
		Sujungimo elementas L = 440 mm	RA1ACJ	Paslėptas, Ruukki® 30, 0.60 mm	7,02 (5,80)
		Ventiliuojami plieniniai grebėstai Ilgis – 3700 mm aukštis – 32 mm storis – 0,7 mm	RA545		16,21 (13,40)

Pagal užsakovo pateiktą brėžinį pagaminti nestandartiniai lankstiniai iki 8 m ilgio, palangės, angokraščiai bei sudėtingi kamino apdailos lankstiniai, įvairūs liukai ir kt.

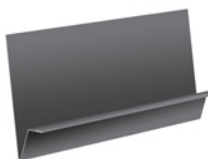
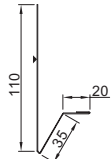

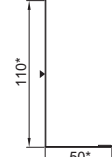
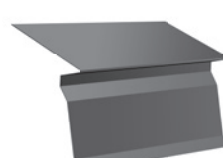
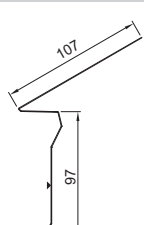
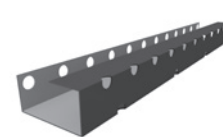
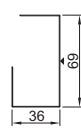
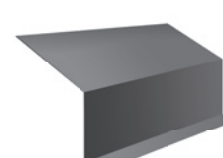
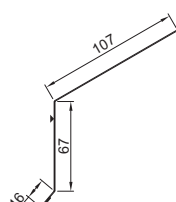

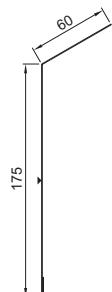

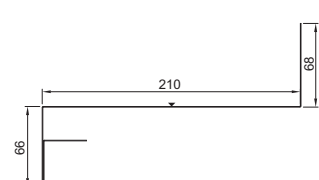
Classic fasadų sprendiniams skirti lankstiniai

Kaina €/vnt. su PVM 21% (€/vnt. be PVM)

Vaizdas	Brėžinys	Pavadinimas	Kokybės klasė	Kaina
		1. Pradžios lankstinys cokoliui L = 2400 mm	Paslėptas lankstinys, Ruukki 40, RR2H3, 0,50 mm	27,65 (22,85)
		2. Perforuotas lankstinys cokoliui * – matmuo pagal poreikį L = 2400 mm * – kaina galioja nurodytiems matmenims	Paslėptas lankstinys, Ruukki 40, RR2H3, 0,50 mm	44,17 (36,50)
		3. Reguliuojama karnizo lenta L = 2000 mm	Ruukki® 50 Plus matt 0,50 mm	20,33 (16,80)
		4. Ventiliuojamas kraigo elementas L = 460 mm L = 340 mm L = 255 mm	Ruukki® 50 Plus matt 0,60 mm	3,51 (2,90) 3,03 (2,50) 2,54 (2,10)
		5. Papildomas karnizo lankstinys L = 2000 mm	Ruukki® 50 Plus matt 0,50 mm	20,33 (16,80)
		6. Viršutinis kondensato nuvedimo lankstinys L = 2400 mm Užsakomi su paslėpta lietaus sistema	Spalvos ir padengimai kaip paslėptos lietaus nuvedimo sistemos 0,50 mm	14,64 (12,20)
		7. Apatinis kondensato nuvedimo lankstinys L = 2400 mm Užsakomi su paslėpta lietaus sistema	Spalvos ir padengimai kaip paslėptos lietaus nuvedimo sistemos 0,50 mm	21,06 (17,55)

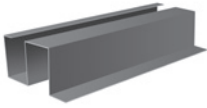
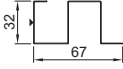
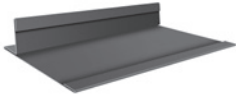
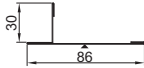

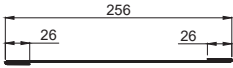
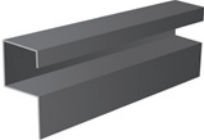
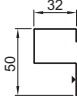
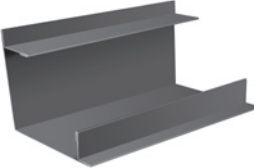
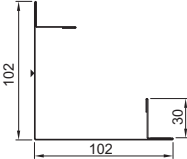
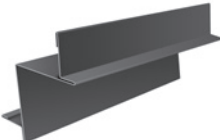
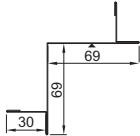

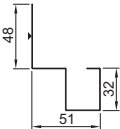

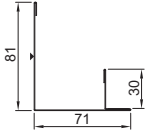
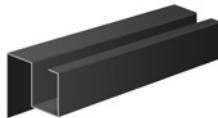
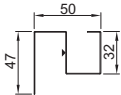

Lankstiniai

Kaina €/vnt. su PVM 21% (€/vnt. be PVM)

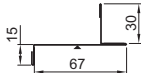
Vaizdas	Brėžinys	Pavadinimas	Kokybės klasė	Kaina
		8. Atraminis fasadų sujungimo lankstinys L = 2400 mm	Paslėptas lankstinys, Ruukki 40, RR2H3 0,50 mm	28,19 (23,30)
		9. Fasadų sujungimo apdailos lankstinys L = 3000 mm	Ruukki® 50 Plus matt 0,50 mm	28,19 (23,30)
		10. Classic lakštų sujungimo lankstinys	Paslėptas, Ruukki® 50, 0.50 mm L = 255 mm L = 340 mm	5,81 (4,80) 6,05 (5,00)
		11. Atraminis išorinio/vidinio kampo lankstinys L = 2400 mm	Paslėptas lankstinys, Ruukki 40, RR2H3 0,50 mm	20,45 (16,90)
		12. Išorinio kampo apdailos lankstinys L = 3000 mm	Ruukki® 50 Plus matt 0,50 mm	60,32 (49,85)
		13. Vidinio kampo apdailos lankstinys L = 3000 mm	Ruukki® 50 Plus matt 0,50 mm	48,04 (39,70)
		14. Atraminis išorinio krašto lankstinys L = 2400 mm	Paslėptas lankstinys, Ruukki 40, RR2H3 0,50 mm	30,13 (24,90)

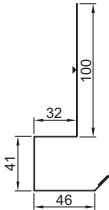

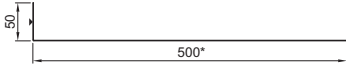

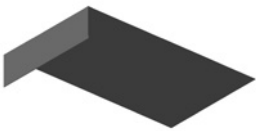
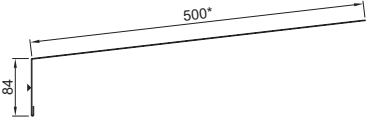

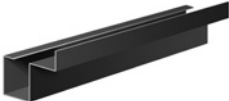
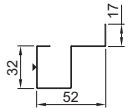
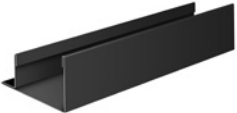
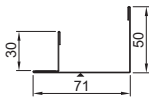

Lankstiniai

Kaina €/vnt. su PVM 21% (€/vnt. be PVM)

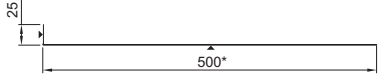
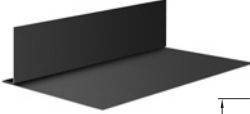
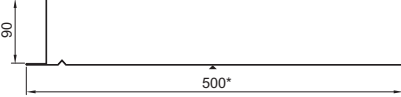
Vaizdas	Brėžinys	Pavadinimas	Kokybės klasė	Kaina
		15. Išorinio krašto apdailos lankstinys L = 3000 mm	Ruukki® 50 Plus matt 0,50 mm	48,04 (39,70)
		16. Atraminis vidinio krašto lankstinys L = 2400 mm	Paslėptas lankstinys, Ruukki 40, RR2H3 0,50 mm	30,13 (24,90)
		17. Vidinio krašto apdailos lankstinys L = 3000 mm	Ruukki® 50 Plus matt 0,50 mm	32,07 (26,50)
		18. Išorinis lango/durų viršaus lankstinys L = 2400 mm	Ruukki® 50 Plus matt 0,50 mm	41,99 (34,70)
		19. Vidinis lango/durų viršaus lankstinys * – matmuo pagal poreikį L = 2400 mm * – kaina galioja nurodytiems matmenims	Ruukki® 50 Plus matt 0,50 mm	43,92 (36,30)
		20. Apatinis palangės lankstinys (plati palangė) L = 2400 mm	Paslėptas lankstinys, Ruukki 40, RR2H3 0,50 mm	11,62 (9,60)
		21. Palangės lankstinys (plati palangė) * – matmuo pagal poreikį L = 2400 mm * – kaina galioja nurodytiems matmenims	Ruukki® 50 Plus matt 0,50 mm	43,92 (36,30)

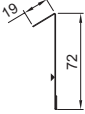
Lankstiniai

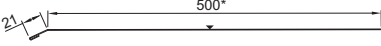
Kaina €/vnt. su PVM 21% (€/vnt. be PVM)

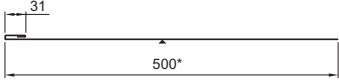
Vaizdas	Brėžinys	Pavadinimas	Kokybės klasė	Kaina
		22. Atraminis lango/durų krašto lankstinys L = 2400 mm	Paslėptas lankstinys, Ruukki 40, RR2H3 0,50 mm	30,13 (24,90)
		23. Lango/durų krašto apdailos lankstinys L = 3000 mm	Ruukki® 50 Plus matt 0,50 mm	41,99 (34,70)
		24. Vidinis lango/durų krašto lankstinys * – matmuo pagal poreikį L = 3000 mm * – kaina galioja nurodytiems matmenims	Ruukki® 50 Plus matt 0,50 mm	49,55 (40,95)
		25. Siauras lango/durų viršaus lankstinys * – matmuo pagal poreikį L = 2400 mm * – kaina galioja nurodytiems matmenims	Ruukki® 50 Plus matt 0,50 mm	57,54 (47,55)
		26. Apatinis palangės lankstinys (siaura palangė) L = 2400 mm	Ruukki® 50 Plus matt 0,50 mm	17,42 (14,40)
		27. Palangės lankstinys (siaura palangė) * – matmuo pagal poreikį L = 2400 mm * – kaina galioja nurodytiems matmenims	Ruukki® 50 Plus matt 0,50 mm	43,92 (36,30)
		28. Siauras lango/durų krašto lankstinys * – matmuo pagal poreikį L = 3000 mm * – kaina galioja nurodytiems matmenims	Ruukki® 50 Plus matt 0,50 mm	49,55 (40,95)

Standartiniai stogo lankstiniai čerpiniams ir profiliuotiems lakštams

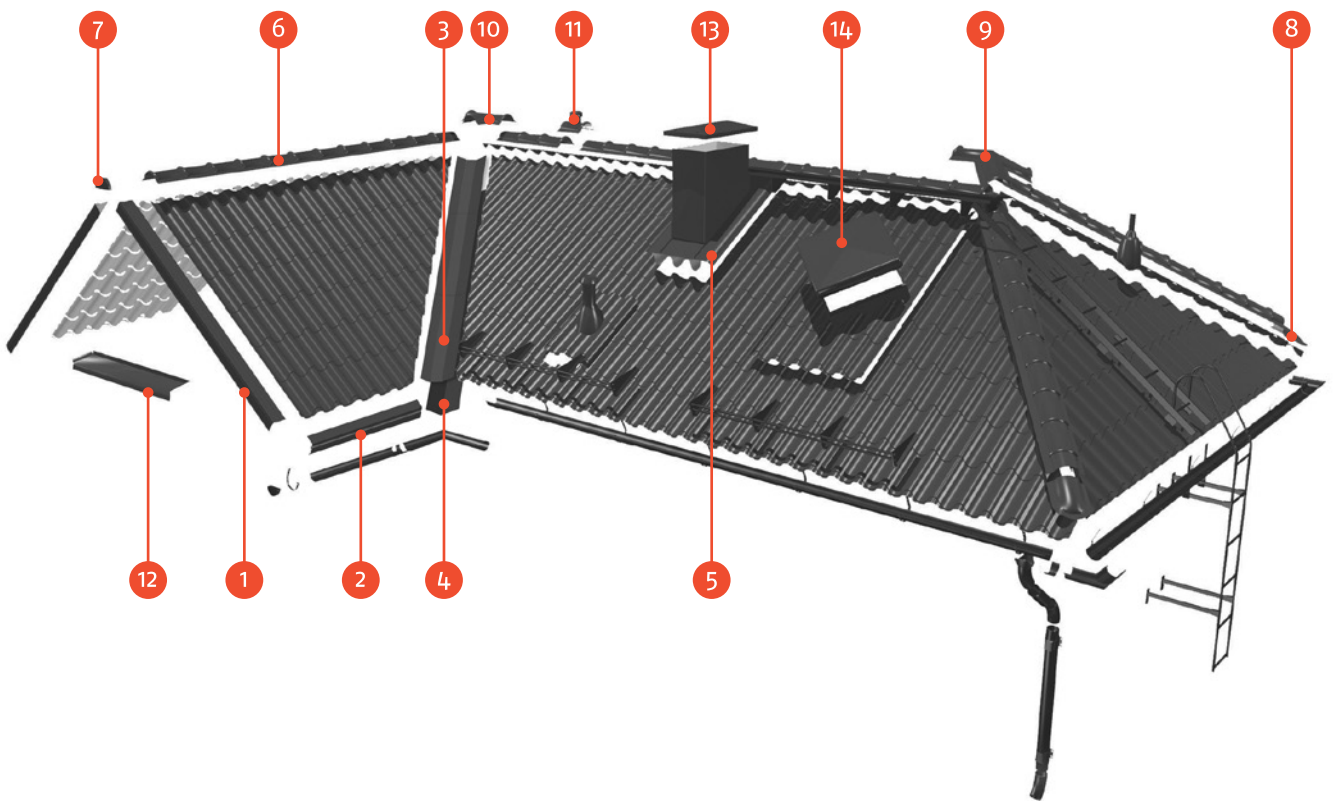

1 Vėjalentė

2 Karnizas

3 Sąlajos uždengimas

4 Apatinė sąlaja

5 Vidinis kampas

6 Kraigas

7 Kraigo dangtelis

8 Kraigo antgalis smailus

9 Y-formos kraigo jungtis

10 T-formos kraigo jungtis

11 Kaminėlis kraigo vėdinimui







12 Palangės, angokraščiai

13 Kamino lankstiniai

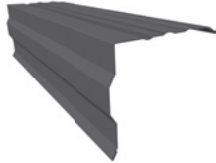
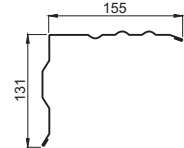
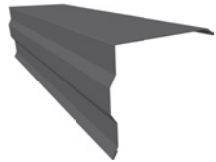
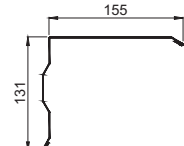
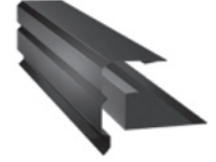
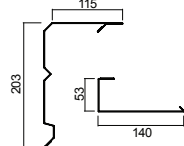
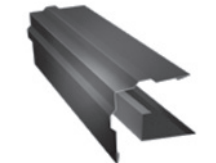
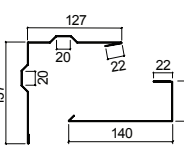
14 Sudėtingų formų lankstiniai, liukai

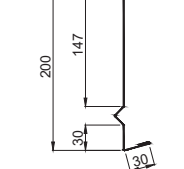
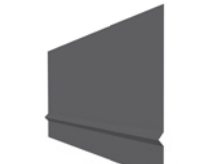
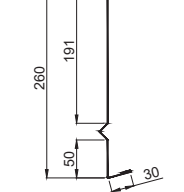

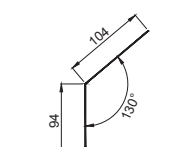

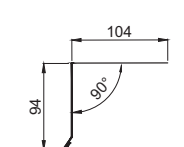

Lankstiniai ir priedai

Kaina €/vnt. su PVM 21% (€/vnt. be PVM)

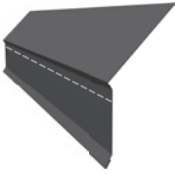
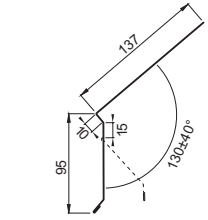
Vaizdas	Brėžinys	Pavadinimas	Kodas	Kokybės klasė	Kaina
		Vėjalentė Adamante Finnera Monterrey FEB Forma ⁺ T20 L = 2000 mm	RA9BG	Ruukki [®] 50 Plus Matt (išskyrus RR21, RR22, RR887, RR2H3) Ruukki [®] 40 (išskyrus RR750, RR887, RR2H3) Ruukki [®] 30 (išskyrus RR21, RR22, RR887, RR2H3)	21,05 (17,40) 19,00 (15,70) 19,00 (15,70)
		Vėjalentė Adamante Finnera Monterrey FEB Forma ⁺ T20 L = 2000 mm	RA9BG-P	Ruukki [®] 50 Plus Matt (tik RR21, RR22, RR887, RR2H3) Ruukki [®] 40 (tik RR750, RR887, R2H3) Ruukki [®] 30 Plus Matt Ruukki [®] 30 (tik RR21, RR22, RR887, RR2H3)	21,05 (17,40) 19,00 (15,70) 19,00 (15,70) 19,00 (15,70)
		Vėjalentė Hygge Hygge vėjalentė susideda iš 2 elementų. L = 2000 mm	30500HY310	Ruukki [®] 40	27,10 (22,40)
		Vėjalentė Frigge Frigge vėjalentė susideda iš 2 elementų. L = 2000 mm	30500FR310	Ruukki [®] 50 Plus Matt Ruukki [®] 40 Ruukki [®] 30 Plus Matt Ruukki [®] 30	31,82 (26,30) 28,92 (23,90) 28,92 (23,90) 28,92 (23,90)
		Vėjalentės apdaila (maža) Hygge L = 2000 mm	195RA1BBC	Ruukki [®] 40	14,28 (11,80)
		Vėjalentės apdaila (didelė) Hygge L = 2000 mm	260RA1BBC	Ruukki [®] 40	16,82 (13,90)
		Karnizas Adamante Finnera Monterrey FEB Forma ⁺ T20 L = 2000 mm	130RA1BE	Ruukki [®] 50 Plus Matt (išskyrus RR22, RR750) Ruukki [®] 40 (išskyrus RR750) Ruukki [®] 30 Plus Matt Ruukki [®] 30 (išskyrus RR33)	20,33 (16,80) 17,55 (14,50) 17,55 (14,50) 15,37 (12,70)
		Karnizas Adamante Finnera Monterrey FEB Forma ⁺ T20 L = 2000 mm	90RA1BE	Ruukki [®] 50 Plus Matt (tik RR21, RR22, RR887, RR2H3) Ruukki [®] 40 (išskyrus RR750) Ruukki [®] 30 Plus Matt Ruukki [®] 30 (išskyrus RR33)	20,33 (16,80) 17,55 (14,50) 17,55 (14,50) 15,37 (12,70)

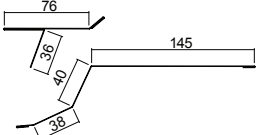

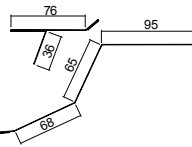
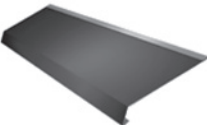
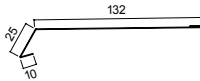
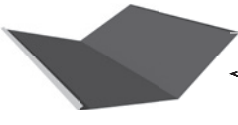
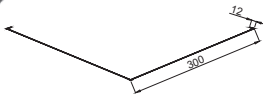
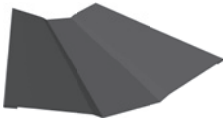
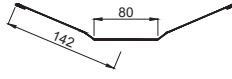
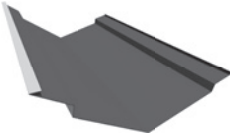
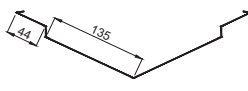

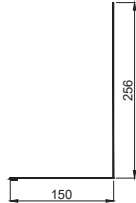



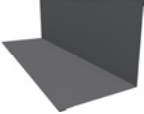
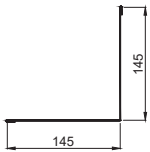

Lankstiniai ir priedai

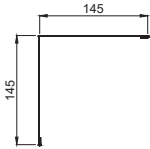
Kaina €/vnt. su PVM 21% (€/vnt. be PVM)

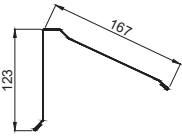
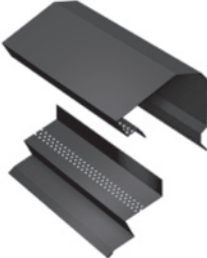
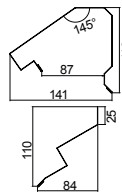
Vaizdas	Brėžinys	Pavadinimas	Kodas	Kokybės klasė	Kaina
		Karnizas (perforuota linija kampo reguliavimui) Adamante Finnera Monterrey FEB Forma ⁺ T20 L = 2000 mm	RA9BEF	Ruukki [®] 50 Plus Matt	20,33 (16,80)
				Ruukki [®] 40 (išskyrus RR887)	17,55 (14,50)
				Ruukki [®] 30 (išskyrus RR22)	15,37 (12,70)
		Karnizas Hygge Hygge karnizas susideda iš 2 elementų. L = 2000 mm		Ruukki [®] 40	21,18 (17,50)
		Karnizas Hygge (didelis) Hygge karnizas susideda iš 2 elementų. L = 2000 mm	30500HY410	Ruukki [®] 40	21,18 (17,50)
		Karnizo lankstinys Hygge L = 2000 mm	30500HY610	Ruukki [®] 40	10,77 (8,90)
		Apatinė sąlaja 625 Adamante Finnera Monterrey FEB Forma ⁺ T20 L = 2000 mm	625RA1BV	Ruukki [®] 50 Plus Matt	49,25 (40,70)
				Ruukki [®] 40	42,11 (34,80)
				Ruukki [®] 30 Plus Matt	42,11 (34,80)
				Ruukki [®] 30	40,54 (33,50)
		Sąlajos uždengimas Adamante Finnera Monterrey FEB Forma ⁺ T20 L = 2000 mm	RA1BVC	Ruukki [®] 50 Plus Matt	25,47 (21,05)
				Ruukki [®] 40	25,47 (21,05)
				Ruukki [®] 30 Plus Matt	23,11 (19,10)
				Ruukki [®] 30	21,05 (17,40)
		Apatinė sąlaja Hygge L = 2000 mm	30500HY510	Ruukki [®] 40	36,91 (30,50)
		Vidinis kampas Adamante Finnera Monterrey FEB Forma ⁺ T20 L = 2000 mm	RA1BJ	Ruukki [®] 50 Plus Matt	39,57 (32,70)
				Ruukki [®] 40	30,73 (25,40)
				Ruukki [®] 30 Plus Matt	30,73 (25,40)
				Ruukki [®] 30	27,65 (22,85)

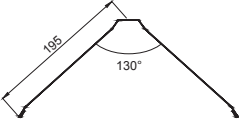

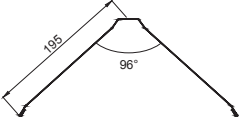

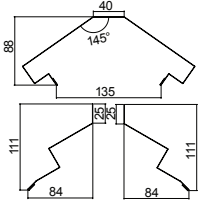

Lankstiniai ir priedai

Kaina €/vnt. su PVM 21% (€/vnt. be PVM)

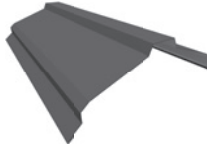
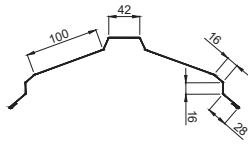
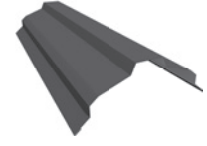
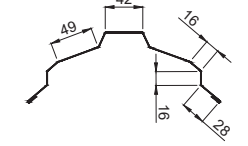
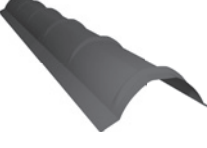
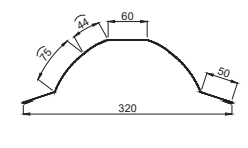
Vaizdas	Brėžinys	Pavadinimas	Kodas	Kokybės klasė	Kaina
		Vidinis kampas Adamante Finnera Monterrey FEB Forma ⁺ T20 L = 2000 mm	RA1CI	Ruukki ⁺ 50 Plus Matt Ruukki ⁺ 40 Ruukki ⁺ 30 Plus Matt Ruukki ⁺ 30	26,56 (21,95) 25,35 (20,95) 25,35 (20,95) 24,40 (20,16)
		Išorinis kampas Adamante Finnera Monterrey FEB Forma ⁺ T20 L = 2000 mm	RA1CE	Ruukki ⁺ 50 Plus Matt Ruukki ⁺ 40 Ruukki ⁺ 30 Plus Matt Ruukki ⁺ 30	26,56 (21,95) 25,35 (20,95) 25,35 (20,95) 24,40 (20,16)
		Vienšlaičio stogo kraigas Adamante Finnera Monterrey FEB Forma ⁺ T20 L = 2000 mm	RA1AEU	Ruukki ⁺ 50 Plus Matt Ruukki ⁺ 40 Ruukki ⁺ 30 Plus Matt Ruukki ⁺ 30	28,31 (23,40) 27,77 (22,95) 27,77 (22,95) 25,17 (20,80)
		Vienšlaičio stogo kraigas Hyygge Hyygge vienšlaičio stogo kraigas susideda iš 2 elementų. L = 2000 mm	30500HY210	Ruukki ⁺ 40	24,14 (19,95)
		Lygus kraigas Adamante Finnera Monterrey FEB Forma ⁺ T20 L = 2000 mm	RA9AR	Ruukki ⁺ 50 Plus Matt (išskyrus RR887, RR2H3) Ruukki ⁺ 40 (išskyrus RR750, RR887, RR2H3) Ruukki ⁺ 30 (išskyrus RR21, RR22, RR887, RR2H3)	25,35 (20,95) 23,11 (19,10) 21,05 (17,40)
		Lygus kraigas Adamante Finnera Monterrey FEB Forma ⁺ T20 L = 2000 mm	RA1AR	Ruukki ⁺ 50 Plus Matt (tik RR887, RR2H3) Ruukki ⁺ 40 (tik RR750, RR887, RR2H3) Ruukki ⁺ 30 Plus Matt Ruukki ⁺ 30 (tik RR21, RR22, RR887, RR2H3)	25,35 (20,95) 23,11 (19,10) 23,11 (19,10) 21,05 (17,40)
		Hyygge kraigas Hyygge kraigas susideda iš 3 elementų. L = 2000 mm	30500HY010	Ruukki ⁺ 40	36,90 (30,50)



Lankstiniai ir priedai

Kaina €/vnt. su PVM 21% (€/vnt. be PVM)

Vaizdas	Brėžinys	Pavadinimas	Kodas	Kokybės klasė	Kaina
		Frigge kraigas L = 2000 mm	30500FR010	Ruukki® 50 Plus Matt Ruukki® 40 Ruukki® 30 Plus Matt Ruukki® 30	25,35 (20,95) 23,11 (19,10) 23,11 (19,10) 21,05 (17,40)
		Frigge kraigas (mazas) L = 2000 mm	30500FR020	Ruukki® 50 Plus Matt Ruukki® 40 Ruukki® 30 Plus Matt Ruukki® 30	24,68 (20,40) 22,26 (18,40) 22,26 (18,40) 20,33 (16,80)
		Apvalus kraigas Adamante Finnera Monterrey FEB Forma® T20 L = 2100 mm	RA9BR0	Ruukki® 50 Plus Matt Ruukki® 40 Ruukki® 30 Plus Matt Ruukki® 30	30,86 (25,50) 26,74 (22,10) 26,74 (22,10) 25,17 (20,80)
		Kraigo antgalis smailus Adamante Finnera Monterrey FEB Forma® T20	RA12H0	Plastikinis	22,08 (18,25)
		Kraigo dangtelis Adamante Finnera Monterrey FEB Forma® T20	RA12E	Plastikinis	4,72 (3,90)
		Y-formos kraigo jungtis Adamante Finnera Monterrey FEB Forma® T20	RA12Y0	Plastikinis	48,28 (39,90)
		T-formos kraigo jungtis Adamante Finnera Monterrey FEB Forma® T20	RA12T	Plastikinis	59,29 (49,00)
		Kaminėlis kraigo vėdinimui Adamante Finnera Monterrey FEB Forma® T20	RA12POP	Plastikinis	72,60 (60,00)
		Kaminėlis kraigo vėdinimui Adamante Finnera Monterrey FEB Forma® T20	RA12PF	Plastikinis	72,60 (60,00)

Lankstiniai ir priedai

Kaina €/vnt. su PVM 21% (€/vnt. be PVM)

Vaizdas	Brėžinys	Pavadinimas	Kodas	Kokybės klasė	Kaina
		Prie gegnių tvirtinamas kraigo tašelio laikiklis Matmenys 40x210 mm Laikiklių skaičius bendroje pakuotėje 100 vnt.			vnt. 1,15 (0,95)
		Reguliuojamas, prie gegnių tvirtinamas kraigo tašelio laikiklis Matmenys 40x202 ÷ 225 mm Laikiklių skaičius bendroje pakuotėje 100 vnt.			vnt. 2,66 (2,20)
		Ventiliuojami plieniniai grebėstai Ilgis – 3700 mm aukštis – 32 mm storis – 0,7 mm			vnt. 16,21 (13,40)



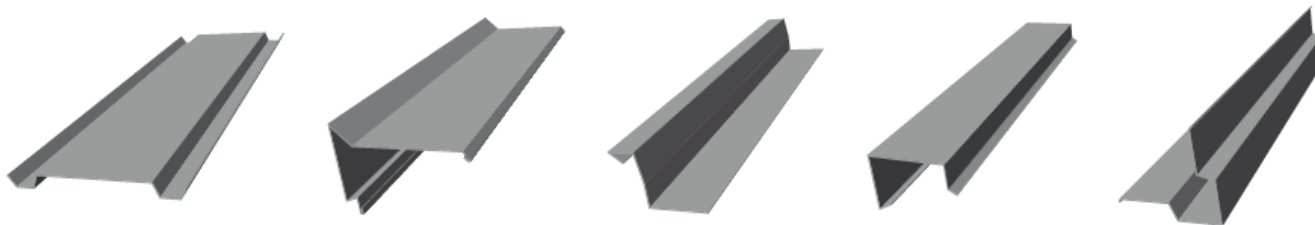



Pagal užsakovo pateiktą brėžinį pagaminti nestandartiniai lankstiniai iki 8 m ilgio, palangės, angokraščiai bei sudėtingi kamino apdailos lankstiniai, įvairūs liukai ir kt.

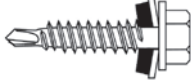

Sraigčiai, plėvelės, dažai, tarpinės, sandarinimo juostos



Sraigčiai

Kaina €/vnt. su PVM 21% (€/vnt. be PVM)

Vaizdas	Pavadinimas	Kodas	Pastabos	Mato vnt.	
	Sraigčiai į medį 4.8 x 28 mm	RAS1WD4828A14	100 vnt./pak., Spalvoti	pak.	9,26 (7,65)
			100 vnt./pak., Zn	pak.	8,71 (7,20)
	Sraigčiai lakštų sujungimui 4.8 x 20...23 mm	RAS1SL24820A14	100 vnt./pak., Spalvoti	pak.	11,25 (9,30)
			100 vnt./pak., Zn	pak.	9,20 (7,60)
	Nerūdijančio plieno sraigčiai Classic tvirtinimui 4.2 x 25 mm	RAS1WP4225PH2	100 vnt./pak., AiSi	pak.	8,83 (7,30)
	Nerūdijančio plieno sraigčiai Classic tvirtinimui 4.2 x 25 mm	RAS1SP4225PH2	AiSi	vnt.	0,19 (0,16)
	Valcuoto profilio laikikliai L = 25	696200000000	Plienas	vnt.	0,097 (0,08)
		69620000000J	Nerūdyjantis plienas	vnt.	0,278 (0,23)
		69621000000J	Paslankūs, nerūdyjantis plienas	vnt.	0,557 (0,46)
	Ruukki LP™ Torx sraigčiai Universalus – tinka ir į medį, ir lakštų sujungimui 4.8 x 28 mm	S1T48028WA4RR	100 vnt./pak., Spalvoti	pak.	13,92 (11,50)
	Magnetinė galvutė Ruukki LP™ Torx sraigčiams		1 vnt. + 5 antgaliai	pak.	17,24 (14,25)





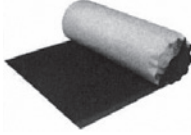
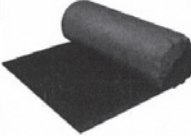





Plėvelės

Kaina €/vnt. su PVM 21% (€/vnt. be PVM)

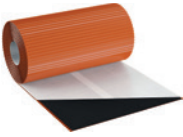
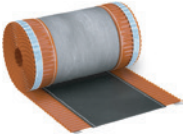
Vaizdas	Pavadinimas	Kodas	Pastabos	Plotis, kiekis rulone	
	Difuzinė plėvelė (rulonais) Kvėpuojanti, su dviem integruotomis lipniomis juostomis	Ruukki 175 FIX	175 g/m ² , armuota, 4 sl.	1.5 m; 75 m ²	209,94 (173,50)
		Ruukki 175 FIX	175 g/m ² , armuota, 4 sl.	1.5 m; 30 m ²	91,90 (75,95)
		Ruukki 145 FIX	145 g/m ² , 3 sl.	1.5 m; 75 m ²	140,30 (115,95)
		Ruukki 145 FIX	145 g/m ² , 3 sl.	1.5 m; 30 m ²	64,55 (53,35)
	Antikondensacinė plėvelė (rulonais) Nekvėpuojanti	Ruukki 50 Plus		1.5 m; 60 m ²	127,66 (105,50)
		Ruukki 50 Plus		1.5 m; 30 m ²	64,74 (53,50)
		Ruukki 30		1.5 m; 60 m ²	58,69 (48,50)
	Permo sec SK (rulonais) Ventiliacinį tarpą užtikrinanti plėvelė, skirta valcuojamiems metaliniams stogams tvirtinti ant ištinio pakloto		550 g/m ²	1.5 m; 37.5 m ²	477,95 (395,00)
	Permo sec 400 SK (rulonais) Ventiliacinį tarpą užtikrinanti plėvelė, skirta valcuojamiems metaliniams stogams tvirtinti ant ištinio pakloto		400 g/m ²	1.5 m; 37.5 m ²	366,63 (303,00)

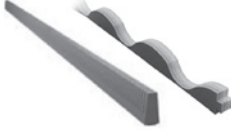
Sandarinimo juostos ir tarpinės

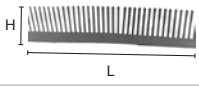
Kaina €/vnt. su PVM 21% (€/vnt. be PVM)

Vaizdas	Pavadinimas	Kodas	Plotis, kiekis rulone	Mato vnt.	
	Ruukki A+ vienpusio lipnumo skaidri juosta	650K	50 mm x 25 m	rul.	28,44 (23,50)
	Klõber Tacto dvipusio lipnumo sandarinimo juosta	65063	20 mm x 50 m	rul.	23,17 (19,15)
	ABSORBER ventiliuojamo tašelio sandarinimo juosta Klõber KU0079-1-50	6401C	50mm x 30m	rul.	41,50 (34,30)
	Permo Seal ventiliuojamo tašelio sandarinimo putas	69J13		1000 g	34,24 (28,30)
	Ruukki FLEXO kamino sandarinimo juosta (pilka, raudona, ruda, juoda)	69J09	300 mm x 5 m	rul.	29,22 (24,15)
	Ruukki ROOL SUPER (pilka, raudona, ruda, juoda)	69J07	310 mm x 5 m	rul.	19,00 (15,70)
	EASY-FORM® universali tampri sandarinimo juosta, aliuminuota	69J16	90mm x 10m	rul.	59,29 (49,00)
	Universali tarpinė	RA3FUNI50	H = 50 mm	m	1,75 (1,45)
		RA3FUNI30	H = 60 mm	m	2,12 (1,75)
	Tarpinė Adamante	RA3FR55350B	L = 1 125 mm	vnt.	1,75 (1,45)
	Tarpinė Monterrey	RA3FR39350B	L = 1 100 mm	vnt.	1,75 (1,45)
	Tarpinė Finnera	RA3FR52330B	L = 1 140 mm	vnt.	1,75 (1,45)
	Tarpinė T20 (didelė)	RA3FR2024B	L = 1 100 mm	vnt.	1,75 (1,45)
	Tarpinė T45 (didelė)	RA3FR4528B	L = 900 mm	vnt.	2,12 (1,75)
	Akustinė tarpinė Classic	RA3ASIB	25 m rulonas	rul.	25,53 (21,10)
			50 m rulonas	rul.	47,80 (39,50)
	Vienpusio lipnumo akustinė Classic juosta	6402C	100 mm x 5 mm x 20 m	rul.	21,24 (17,55)
	Užtvara nuo paukščių čerpiniams profiliais RR23, RR32, RR33	RA4VG	L = 1 000 mm H = 60 mm	vnt.	1,45 (1,20)
	Sandarinimo mastika skaidri drėgniems paviršiams	69J07	280 ml	vnt.	12,71 (10,50)

Dažai, kaminėliai ir įvadai







Dažai

Kaina €/vnt. su PVM 21% (€/vnt. be PVM)

Vaizdas	Pavadinimas	Kodas	Pastabos	
	Dažai	RA6RP0024	24 ml	8,11 (6,70)
	Dažai matiniai	RA6RP0024M	24 ml	9,14 (7,70)
	Dažai	RA6RP01	100 ml	15,25 (12,60)

Kaminėliai

Kaina €/vnt. su PVM 21% (€/vnt. be PVM)

Vaizdas	Pavadinimas	Kodas	Pastabos		
	Kaminėlis su elektriniu ventiliatorium	67305	160 mm ø	E220P	462,22 (382,00)
		67037	125 mm ø	E190P	431,97 (357,00)
	Neapšiltintas alsuoklis FLOW su gaubtu	67325	110 mm ø	h=300 mm	38,11 (31,50)
	Apšiltintas alsuoklis FLOW su gaubtu	67324	110 mm ø	h=350 mm	68,12 (56,30)
	Pritekėjimo elementas 160/IS/500	67131	160 mm ø	h=500 mm	234,74 (194,00)
	Kaminėlis FLOW 125	67333	125 mm ø	h=500 mm	98,86 (81,70)
	Kaminėlis FLOW 160	67326	160 mm ø	h=500 mm	159,11 (131,50)

Kaminėlių, kaminėlių pagrindų ir Solar praėjimų spalvos

Raudonos plytos
(RR750)

Raudona
(RR29)

Tamsi ruda
(RR32)

Žalia
(RR11)

Tamsi pilka
(RR23)

Juoda
(RR33)

Kaminėlių pagrindai

Kaina €/vnt. su PVM 21% (€/vnt. be PVM)

Vaizdas	Pavadinimas	Kodas	Pastabos	
	Kaminėlio pagrindas Classic (nuolydis 11,5-57 laipsniai)	67116	VINO, Ø 75-160 mm	40,05 (33,10)
	Kaminėlio pagrindas Classic (nuolydis 5-27 laipsniai)		LOIVA, Ø 75-160 mm	51,30 (42,40)
	Kaminėlio pagrindas Adamante	67096a		57,11 (47,20)
	Kaminėlio pagrindas Monterrey	67096		49,25 (40,70)
	Kaminėlio pagrindas Frigge	6725K		65,10 (53,80)
	Kaminėlio pagrindas Finnera	67096T	Nera	57,11 (47,20)
	Universalus kaminėlio pagrindas	67097	Pelti	68,85 (56,90)
	Kaminėlio pagrindas Hyygge	6725H		57,11 (47,20)
	Vilpe 2K hidroizoliacinis sandariklis	64M11		23,41 (19,35)

Įvada ir Solar praėjimai

Kaina €/vnt. su PVM 21% (€/vnt. be PVM)

Vaizdas	Pavadinimas	Kodas	Pastabos	
	Įvado lizdas	67100	12-102 mm	27,28 (22,55)
	Įvado lizdas	67099	121-254 mm	40,89 (33,79)
	Vamzdžio praėjimas 110-155 Juodas	67244	110-155 mm Ø	43,32 (35,80)
	Solar praėjimas Classic	67M12		86,76 (71,70)
	Solar praėjimas čerpiams profiliams	67M10		94,38 (78,00)
	Solar universalus praėjimas			142,05 (117,40)
	Solar praėjimų kabelių sandariklis Juodas			18,76 (15,50)

Standartinė apvali lietaus vandens nuvedimo sistema







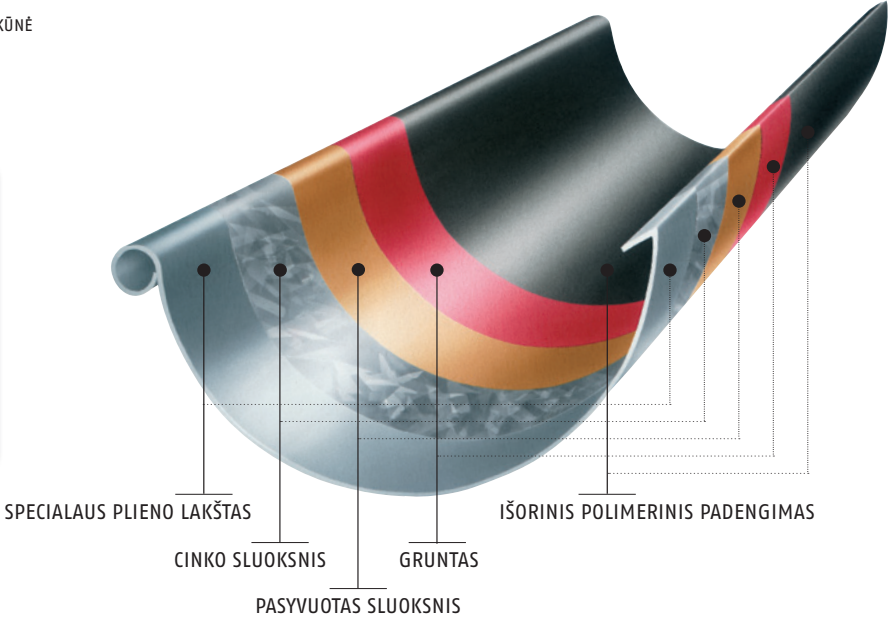
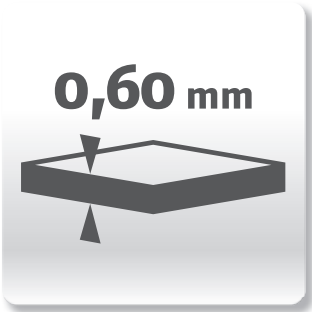







MONTAVIMO IR NAUDOJIMO INSTRUKCIJA

YouTube
www.ruukki.lt/r













Latai ir priedai

Kaina €/vnt. su PVM 21% (€/vnt. be PVM)

Vaizdas	Pavadinimas	Plotis	Kodas	Pastabos	Standartinis padengimas (GreenCoat RWS)	Matinis padengimas (GreenCoat RWS PRO BT Matt)
	101 Latakas	125 mm	5513e00000A	3.0 m	20,81 (17,20)	22,69 (18,75)
		125 mm	5514e00000A	4.0 m	27,71 (22,90)	30,19 (24,95)
		150 mm	5513g00000A	3.0 m	26,86 (22,20)	
		150 mm	5514g00000A	4.0 m	35,27 (29,15)	
	102 Vidinis kampas 90°	125 mm	5521e00000A		17,06 (14,10)	18,63 (15,40)
		150 mm	5521g00000A		19,12 (15,80)	
	103 Išorinis kampas 90°	125 mm	5522e00000A		17,06 (14,10)	18,63 (15,40)
		150 mm	5522g00000A		19,12 (15,80)	
	102-9 Vidinis kampas 135°	125 mm	5523e00000A		43,38 (35,85)	
		150 mm	5523g00000A		44,53 (36,80)	
	103-9 Išorinis kampas 135°	125 mm	5524e00000A		43,38 (35,85)	
		150 mm	5524g00000A		44,53 (36,80)	
	115 Latako galas COMBI	125 mm	5547e00000A		4,96 (4,10)	5,46 (4,51)
		150 mm	5547g00000A		7,02 (5,80)	
	190 Reguliuojamas laikiklis	125 mm	5551e00000A		6,73 (5,55)	7,32 (6,05)
		150 mm	5551g00000A		10,16 (8,40)	
	169 Kompaktiškas laikiklis	125 mm	5559e00000A		2,18 (1,80)	2,40 (1,98)
		150 mm	5559g00000A		3,09 (2,55)	
	Latako laikiklis Strong 125	125 mm	556Ae00000A		5,45 (4,50)	
	166 Ilgas tiesus laikiklis	125 mm	5556e00000A	205 ilgas	4,36 (3,60)	4,78 (3,95)
	168 Trumpas tiesus laikiklis	125 mm	5558e00000A	55 trumpas	3,51 (2,90)	3,86 (3,19)
		150 mm	5556g00000A	210 ilgas	4,48 (3,70)	
		150 mm	5558g00000A	55 trumpas	3,75 (3,10)	
	142 Latako sujungimo apkaba	125 mm	5531e00000A		4,96 (4,10)	5,45 (4,50)
		150 mm	5531g00000A		5,32 (4,40)	
	Latako sujungimo apkaba (plati)	125 mm	5535e000001		7,38 (6,10)	8,11 (6,70)

Lietvamzdžiai ir priedai

Kaina €/vnt. su PVM 21% (€/vnt. be PVM)

Vaizdas	Pavadinimas	Plotis	Kodas	Pastabos	Standartinis padengimas (GreenCoat RWS)	Matinis padengimas (GreenCoat RWS PRO BT Matt)
	220 Lietvamzdis	90 mm	5611m00000A	1.0 m	13,67 (11,30)	15,00 (12,40)
		90 mm	5612m00000A	2.5 m	23,41 (19,35)	25,77 (21,30)
		90 mm	5614m00000A	4.0 m	35,70 (29,50)	39,26 (32,45)
		100 mm	561100000A	1.0 m	21,18 (17,50)	
		100 mm	561200000A	2.5 m	30,13 (24,90)	
		100 mm	561400000A	4.0 m	43,20 (35,70)	
	112 Įlaja	90 mm	5582m00000A		11,01 (9,10)	12,10 (10,00)
		100 mm	55832000000A		16,36 (13,50)	
	217 Viršutinė alkūnė	90 mm	5632m00000A		7,02 (5,80)	7,72 (6,38)
		100 mm	56320000000A		7,99 (6,60)	
	226 Apatinė alkūnė	90 mm	5641m00000A		8,23 (6,80)	9,05 (7,48)
		100 mm	56410000000A		9,26 (7,65)	
	221 Lietvamzdžio jungtis	90 mm	5664m00000A		4,90 (4,05)	5,38 (4,45)
		100 mm	56640000000A		5,26 (4,35)	
	Lietvamzdžio laikiklis (pleištinis)		5657m00000A	90 mm	3,09 (2,55)	3,39 (2,80)
			56520000000A	100 mm	4,96 (4,10)	
	245 Y-jungtis	90 mm	5635m00000A		52,51 (43,40)	57,76 (47,74)
		100 mm	56350000000A		53,60 (44,30)	
	241 Vandens surinkėjas	90 mm	5663m00000A		63,89 (52,80)	
		100 mm	56630000000A		67,64 (55,90)	
	227 Įvadas į žemę	90 mm	5662m00000A		33,64 (27,80)	36,91 (30,50)
		100 mm	56620000000A		42,35 (35,00)	
	457 Lietvamzdžio perėjimas lapų gaudyklei (plastikinis)		58320000001	80-150	5,46 (4,50)	

Kaina €/vnt. su PVM 21% (€/vnt. be PVM)

Vaizdas	Pavadinimas	Plotis	Kodas	Pastabos	Standartinis padengimas (GreenCoat RWS)	Matinis padengimas (GreenCoat RWS PRO BT Matt)
	458 Išsivalančioji lapų gaudyklė (plastikinė)		5834000000		25,05 (20,70)	
	117 Tiesusis apsaugas nuo pratekėjimo		5822000000		28,68 (23,70)	
	116 Kampinis apsaugas nuo pratekėjimo		5821000000		33,03 (27,30)	
	238 Piltuvas	90	5621m00000A		52,15 (43,10)	
		100	5621000000A		56,14 (46,40)	

Ruukki standartinės lietaus nuvedimo sistemos spalvos (GreenCoat RWS padengimas)

Raudonos plytos (RR750)	Raudona (RR29)	Šokoladinė (RR887)	Tamsi ruda (RR32)	Tamsi sidabrinė (RR41)	Balta (RR20)
Tamsi pilka (RR23)	Antracito (RR2H3)	Juoda (RR33)	Sidabro (RR40)		

Ruukki matinės lietaus nuvedimo sistemos spalvos (GreenCoat RWS PRO BT Matt padengimas)

Juoda (RR33)

Siba Tech universali gilių latakų lietaus sistema

NAUJIENA

Siba Tech latakų sistema – tai sprendimas, kuriame naujoviška latakų forma sujungia pusapvalės ir kvadratinės sistemos privalumus. Sistema Siba Tech leidžia pasirinkti latakų priekį vienoje sistemoje, o tai taip pat reiškia, kad estetinį vaizdą galima priderinti prie kiekvieno namo.



Siba Tech apvalipriekinė dalis

1. Latakas
2. Išorinis apvalus kampas
3. Vidinis apvalus kampas
4. Latakų sujungimo apkaba
5. Latakų galas
6. Laikiklis
7. Apvalus lietvamzdis
8. Apvalaus lietvamzdžio įlaja
9. Viršutinė alkūnė
10. Apatinė alkūnė
11. Lietvamzdžio laikiklis

NAUJIENA

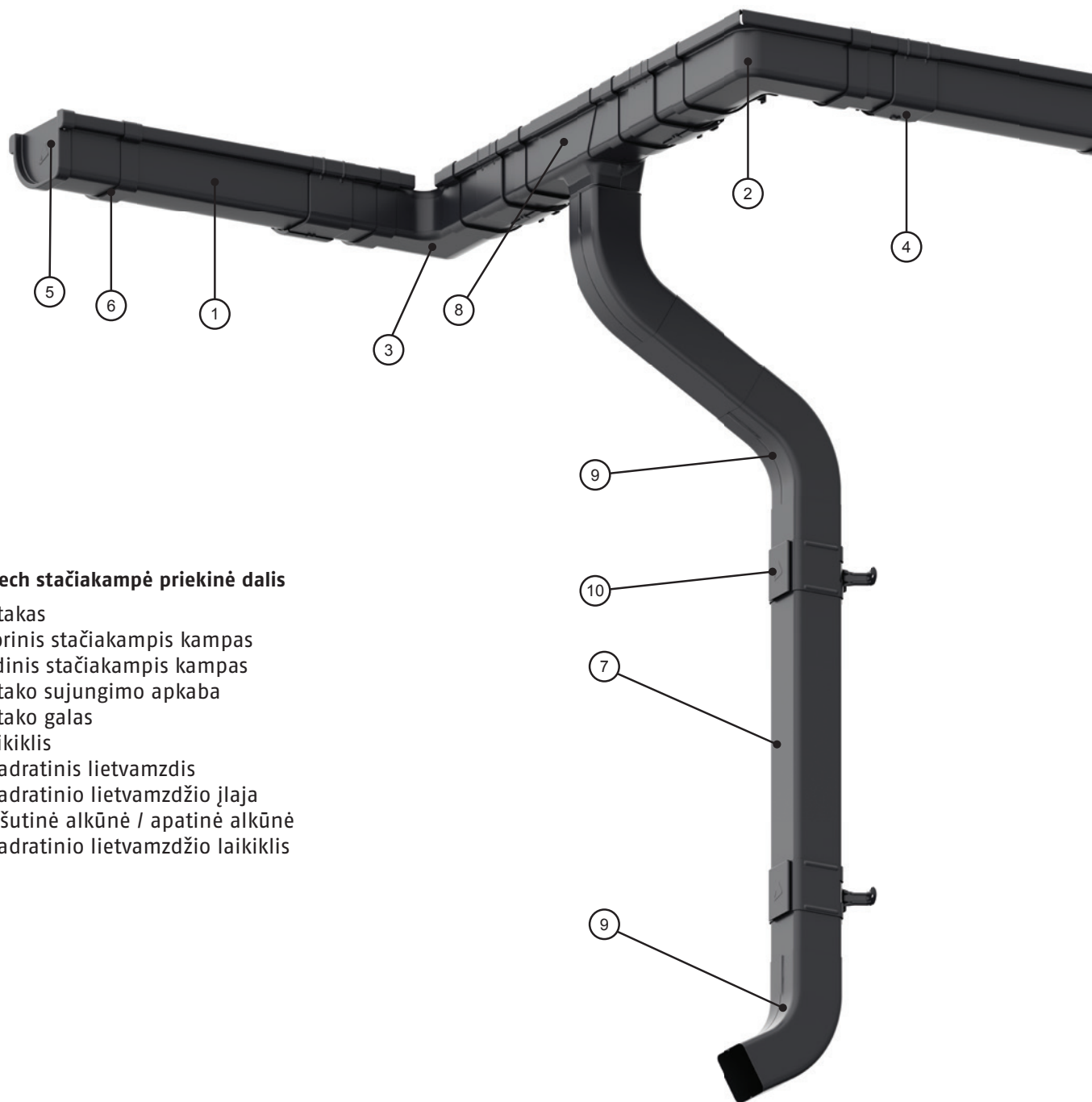

Siba Tech stačiakampė priekinė dalis













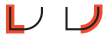

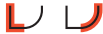



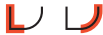



1. Latakas
2. Išorinis stačiakampis kampas
3. Vidinis stačiakampis kampas
4. Latako sujungimo apkaba
5. Latako galas
6. Laikiklis
7. Kvadratinis lietvamzdis
8. Kvadratinio lietvamzdžio įlaja
9. Viršutinė alkūnė / apatinė alkūnė
10. Kvadratinio lietvamzdžio laikiklis

Ruukki standartinės lietaus nuvedimo sistemos spalvos (GreenCoat RWS padengimas)

Šokoladinė (RR887)	Tamsi pilka (RR23)	Antracito (RR2H3)	Juoda (RR33)
-----------------------	-----------------------	----------------------	-----------------























Siba Tech gilių latakų lietaus sistemos komponentai

Kaina €/vnt. su PVM 21% (€/vnt. be PVM)

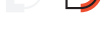
Vaizdas	Pavadinimas	Dydis	Ilgis	Kiekis pakuotėje	Kaina su PVM
	Latakas 	140 mm	4000 mm	3	38,12 (31,50)
		140 mm	3000 mm	3	28,62 (23,65)
	Vidinis stačiakampis / išorinis apvalus kampas 	140 mm		15	13,79 (11,40)
	Išorinis stačiakampis / vidinis apvalus kampas 	140 mm		15	13,79 (11,40)
	Latako sujungimo apkaba 	140 mm		20	7,38 (6,10)
	Kairinis stačiakampis / dešininis apvalus latakų galas 	140 mm		50	3,27 (2,70)
	Dešininis stačiakampis / kairinis apvalus latakų galas 	140 mm		50	3,27 (2,70)
	P tipo (trumpas) stačiakampis DDC laikiklis 	140 mm		25	10,59 (8,75)
	H tipo (kompaktiškas) stačiakampis DDC laikiklis 	140 mm		30	3,81 (3,15)
	Ilgas stačiakampis laikiklis 	140 mm		25	11,74 (9,70)
	P tipo (trumpas) apvalus DDC laikiklis 	140 mm		25	10,59 (8,75)
	H tipo (kompaktiškas) apvalus DDC laikiklis 	140 mm		30	3,81 (3,15)
	Ilgas apvalus laikiklis 	140 mm		25	11,74 (9,70)

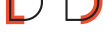
Siba Tech gilių latakų lietaus sistemos komponentai

Kaina €/vnt. su PVM 21% (€/vnt. be PVM)

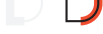
Vaizdas	Pavadinimas	Dydis	Ilgis	Kiekis pakuotėje	Kaina su PVM
	Kvadratinis lietaus vamzdis 	80 x 80 mm	3000 mm	2	34,49 (28,50)
		80 x 80 mm	1000 mm	2	12,34 (10,20)
	Kvadratinio lietaus vamzdžio įlaja 	140 / 80 x 80		20	9,26 (7,65)
	Kvadratinė viršutinė / apatinė alkūnė 	80 x 80 mm		25	7,74 (6,40)
	Kvadratinio lietaus vamzdžio laikiklis 	80 x 80 mm		20	3,09 (2,55)
	Apvalus lietaus vamzdis 	90 mm	3000 mm	2	31,34 (25,90)
		90 mm	1000 mm	2	14,64 (12,10)
	Apvalaus lietaus vamzdžio įlaja 	140 / 90		20	9,26 (7,65)
	Apvalaus lietaus vamzdžio viršutinė alkūnė 	90 mm		16	7,02 (5,80)
	Apvalaus lietaus vamzdžio apatinė alkūnė 	90 mm		16	8,23 (6,80)
	Apvalaus lietaus vamzdžio laikiklis 	90 mm		15	3,09 (2,55)
	Iššivalančioji lapų gaudyklė (plastikinė) 			5	25,05 (20,70)
	Kvadratinio lietaus vamzdžio kolektorius* 	Skirtas kvadratiniam lietaus vamzdžiui 80 x 80 mm		1	47,80 (39,50)
	Apvalaus lietaus vamzdžio kolektorius* 	Skirtas apvaliam lietaus vamzdžiui 75, 90, 100		1	47,80 (39,50)

* Elementas pagamintas iš PVC



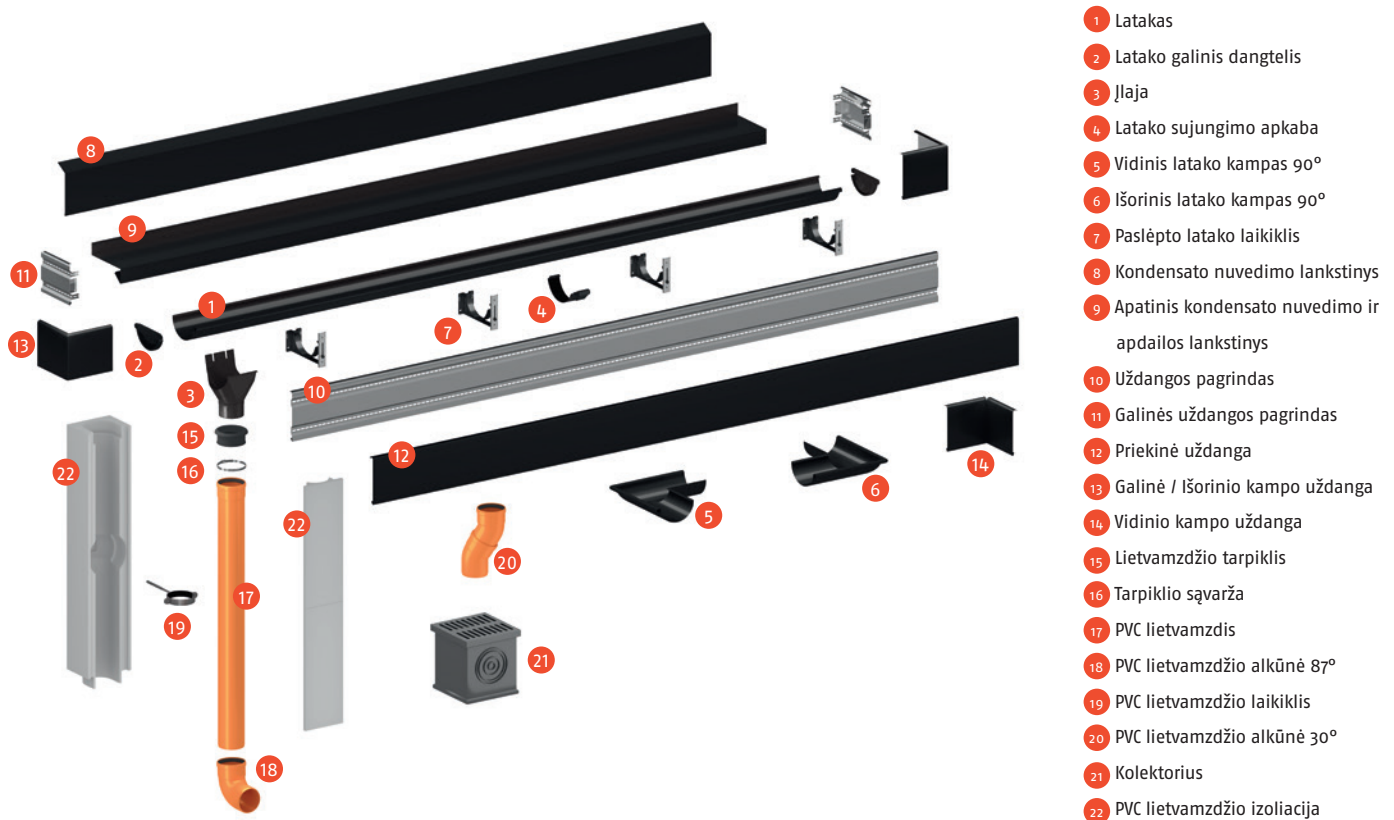



Paslėptoji lietaus nuvedimo sistema





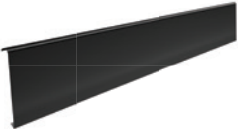



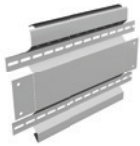
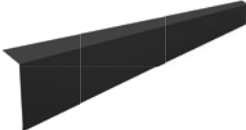
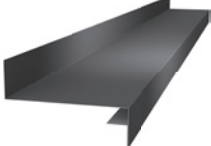

Kaina €/vnt. su PVM 21% (€/vnt. be PVM)

Vaizdas	Pavadinimas		Pastabos
	1. Latakas	150 mm 2,0 m	22,51 (18,60)
		150 mm 4,0 m	45,01 (37,20)
	3. Įlaja	150/100 mm	16,36 (13,50)
	7. Paslėpto latakų laikiklis	150 mm	19,30 (15,95)
	4. Latakų sujungimo apkaba	150 mm	7,87 (6,50)
	6. Išorinis latakų kampas 90°	150 mm	19,60 (16,20)

Kaina €/vnt. su PVM 21% (€/vnt. be PVM)

Vaizdas	Pavadinimas	Pastabos	
	5. Vidinis latako kampas 90° 150 mm		19,60 (16,20)
	2. Latako galinis dangtelis 150 mm		7,20 (5,80)
	12. Priekinė uždanga L = 2400 mm	Ruukki® 50 Plus matt	18,39 (15,20)
		Ruukki® 40	17,55 (14,50)
	14. Vidinio kampo uždanga 210 x 210 mm	Ruukki® 50 Plus matt	6,17 (5,10)
		Ruukki® 40	5,69 (4,70)
	13. Išorinio kampo / galinė uždanga 210 x 210 mm	Ruukki® 50 Plus matt	6,17 (5,10)
		Ruukki® 40	5,69 (4,70)
	10. Uždangos pagrindas L = 2400 mm		18,76 (15,50)
	11. Galinės uždangos pagrindas		5,69 (4,70)
	8. Kondensato nuvedimo lankstinys L = 2400 mm	Ruukki® 50 Plus matt	14,64 (12,20)
		Ruukki® 40	14,04 (11,70)
	9. Apatinis kondensato nuvedimo ir apdailos lankstinys L = 2400 mm	Ruukki® 50 Plus matt	21,06 (17,55)
		Ruukki® 40	19,74 (16,45)

Kaina €/vnt. su PVM 21% (€/vnt. be PVM)

Vaizdas	Pavadinimas		Pastabos	
	17. PVC lietvamzdis	110 mm	3,0 m	22,26 (18,40)
			1,0 m	9,32 (7,70)
	19. PVC lietvamzdžio laikiklis	110 mm	90 mm	4,60 (3,80)
			150 mm	6,78 (5,60)
	18. PVC lietvamzdžio alkūnė 87°	110 mm		5,08 (4,20)
	20. PVC alkūnė 30°	110 mm		4,24 (3,50)
	22. PVC lietvamzdžio izoliacija Komplekte: pagrindas ir dangtelis		1,0 m	9,08 (7,50)
	15. Lietvamzdžio tarpiklis	110 mm		7,50 (6,20)
	16. Tarpiklio sąvarža	110 mm		5,08 (4,20)
	21. Kolektorius	110 mm	200 x 200 x 200 mm	52,03 (43,00)

Paslėptosios lietaus nuvedimo sistemos spalvos

RR22
tik Ruukki 50 Plus Matt

RR23

RR2H3

RR33

Stogo saugos elementai

Stogo tilteliai



Kaina €/vnt. su PVM 21% (€/vnt. be PVM)

Vaizdas	Pavadinimas	Kodas	Pastabos	
	Stogo tiltelis	604530	600 mm	43,74 (36,15)
		604520	1400 mm	84,34 (69,70)
		604510	3000 mm	149,07 (123,20)
	Sniego užtvaros ir stogo tiltelio tvirtinimo kojelės *	6050A	Monterrey, Adamante, Frigge, kaina už 2 vnt. komplektą	37,21 (30,75)
		6050D	Finnera, kaina už 2 vnt. komplektą	37,21 (30,75)
		6050E	T20, kaina už 2 vnt. komplektą	37,21 (30,75)
	Sniego užtvaros ir tiltelio tvirtinimo kojelės UniSeam *	6050B	Classic, Valcinis profilis, kaina už 2 vnt. komplektą	50,22 (41,50)
	Stogo tiltelio tvirtinimo plokštelės * (2 vnt. plokštelių)	60465	Reguliuojamas posvyrio kampas 5°–45° laipsniai	20,69 (17,10)
	Universali atraminė plokštė sutapdintiems stogams		Įeina plokštė (576), varžtas (662) ir veržlė (663)	24,88 (20,56)

* Parduodama 2 kojelių pakuotėmis – komplektais. Komplekte yra visi reikalingi tvirtinimo ir sandarinimo elementai.

Sniego užtvaros



Kaina €/vnt. su PVM 21% (€/vnt. be PVM)

Vaizdas	Pavadinimas	Kodas	Pastabos	
	Sniego užtvaros apvalus vamzdis (502)	60401	3000 mm, kaina už 1 vamzdį	34,67 (28,65)
	Sniego užtvaros ir stogo tiltelio tvirtinimo kojelės *	6050A	Monterrey, Adamante, Frigge, kaina už 2 vnt. komplektą	37,21 (30,75)
		6050D	Finnera, kaina už 2 vnt. komplektą	37,21 (30,75)
		6050E	T20, kaina už 2 vnt. komplektą	37,21 (30,75)
		6050C	Hyygge, kaina už 2 vnt. komplektą	61,41 (50,75)
	Sniego užtvaros ir tiltelio tvirtinimo kojelės UniSeam *	6050B	Classic, Valcinis profilis, kaina už 2 vnt. komplektą	50,22 (41,50)

* Parduodama 2 kojelių pakuotėmis – komplektais. Komplekte yra visi reikalingi tvirtinimo ir sandarinimo elementai.









SOLAR laikikliai

Kaina €/vnt. su PVM 21% (€/vnt. be PVM)

Vaizdas	Pavadinimas	Kodas	Pastabos	
	Saulės elementų laikiklis UniSeam (680+671)	60630	Classic ir valciniams profiliams	14,58 (12,05)
	Saulės elementų laikiklis universalus (681+tarpinės)	60642	Trapeciniams ir čerpiniams profiliams	18,88 (15,60)

Kopėčios

Kaina €/vnt. su PVM 21% (€/vnt. be PVM)

Vaizdas	Pavadinimas	Kodas	Pastabos	
	Kopėčios SafeGrip (400 mm pločio)	60101012	1200 mm	61,47 (50,80)
		60101027	2700 mm	117,13 (96,80)
		60101033	3300 mm	141,45 (116,90)
	Stogo kopėčių kojelių ir tvirtinimo detalių komplektas As3/8 Komplekte: 4 poros kojelių, tarpinės, varžtai, sraigtai	60301	Adamante, Monterrey, Finnera, T20, Hyygge	76,59 (63,30)
	Stogo kopėčių kojelių ir centrinio tvirtinimo detalių komplektas UniSeam Komplekte: 4 poros kojelių, 2 centrinio tvirtinimo detalės, 4 UniSeam fiksatoriai, tarpinės, varžtai, veržlės	60302	Classic ir valcinis profilis	107,57 (88,90)
	Papildomų kopėčių tvirtinimo kojelių komplektas*	60310	Plieniniams, Classic ir Valciniams stogams	13,43 (11,10)
	Kopėčių tvirtinimo komplektas sienai (431)	60122	Komplekte: 2 viršutiniai lankai (turėklai), 4 vnt. 1000 mm ilgio kojelės su apkabomis, 2 vnt. karnizo atotamos, 2 vnt. lankų sujungimo su kopėčiomis detalės, 2 vnt. lankų tvirtinimo prie stogo detalės, sraigtai, varžtai.	213,81 (176,70)
	Papildomos kopėčių tvirtinimo kojelės sienai 1000 (432)	60121	Komplekte: 2 vnt. 1000 mm ilgio kojelės su apkabomis, sraigtai, varžtai	66,49 (54,95)
	Kopėčių lankų (turėklų) tvirtinimo prie tiltelio komplektas (414)	60125		18,63 (15,40)
	Kopėčių turėklų apatinių lankų komplektas (433)	60124		71,05 (58,72)

Kopėčios

Kaina €/vnt. su PVM 21% (€/vnt. be PVM)

Vaizdas	Pavadinimas	Kodas	Pastabos	
	Avarinių kopėčių tvirtinimo komplektas sienai (438)	60161		60,68 (50,15)
	Avarinių kopėčių tvirtinimo kojelės sienai (437)	60162	pora, kojelių ilgis 200 mm	21,66 (17,90)
	Sieninių kopėčių tvirtinimo detalė 60126 prie daugiasluoksnių plokščių (416)	60126		166,98 (138,00)

Apsauginės tvorelės

Kaina €/vnt. su PVM 21% (€/vnt. be PVM)

Vaizdas	Pavadinimas	Kodas	Pastabos	
	Apsauginė tvorelė be sniego užtvaros (2 vamzdžiai) L = 6.0 m H = 0.6 m	L3381	Profiliams	453,75 (375,00)
		L3421	Valciniams	496,10 (410,00)
		L3461	Classic	514,25 (425,00)
	Apsauginė tvorelė su sniego užtvara (4 vamzdžiai) L = 6.0 m H = 0.6 m	L3391	Profiliams	532,40 (440,00)
		L3431	Valciniams	586,85 (485,00)
		L3471	Classic	605,00 (500,00)
	Apsauginė tvorelė be sniego užtvaros (4 vamzdžiai) L = 6.0 m H = 1.2 m	L3401	Profiliams	605,00 (500,00)
		L3441	Valciniams	665,50 (550,00)
		L3481	Classic	689,70 (570,00)
	Apsauginė tvorelė su sniego užtvara (6 vamzdžiai) L = 6.0 m H = 1.2 m	L3411	Profiliams	665,50 (550,00)
		L3451	Valciniams	738,10 (610,00)
		L3491	Classic	762,30 (630,00)

Stogo saugos elementų spalvos

Raudonos plytos (RR750)	Raudona (RR29)	Šokoladinė (RR887)	Tamsi ruda (RR32)	Žalia (RR11)	Balta (RR20)
Šviesi pilka (RR21)	Tamsi pilka (RR23)	Antracito (RR2H3)	Juoda (RR33)		



Apsaugai nuo kritimo – vielinio lyno sistema Ruukki SafeLine

Kaina €/vnt. su PVM 21% (€/vnt. be PVM)

Vaizdas	Pavadinimas	Kodas	Pastabos	
	SafeLine lino laikiklis	34300		21,05 (17,40)
	SafeLine lino laikiklio komplektas	952	Komplekte laikiklis, 2 varžtai ir 2 veržlės	21,66 (17,90)
	Lino laikiklio tvirtinimo prie kopėčių detalė	34301		13,43 (11,10)
	SafeLine lino laikiklio komplektas kopėčioms	953	Komplekte laikiklis, laikiklio tvirtinimo prie kopėčių detalė, 2 varžtai ir 2 veržlės	35,09 (29,00)
	Slankiklio stabdiklis kopėčioms	34303		16,64 (13,75)
	Galinis slankiklio stabdiklis lino laikikliui	34306		7,99 (6,60)
	Galinis lino laikiklis	34323		10,65 (8,80)
	M8 flanšinis varžtas, 20 mm, ir M8 flanšinė veržlė	82443	Varžtas	1,19 (0,98)
		82468	Veržlė	0,85 (0,70)
	Galinė lino apsauga	34317		12,34 (10,20)
	Slankiklis 8 mm plieniniam lynui	34318		97,41 (80,50)
	8 mm nerūdijančio plieno lynas su galiniais elementais, reikiamo ilgio	34000–34029	1–30 m (kas metras) Kaina už 1 m	Klausti pardavėjo
	8 mm nerūdijančio plieno lynas	34050	8 mm lynas, reikiamo ilgio < 50 m, kaina už 1 m	12,71 (10,50)
		34250	8 mm lynas, 10 m	127,05 (105,00)
		34251	8 mm lynas, 20 m	199,65 (165,00)
		34252	8 mm lynas, 50 m	411,40 (340,00)
	8 mm nerūdijančio plieno lynas ritėse	34253	8 mm lino ritė, 100 m	798,60 (660,00)
		34254	8 mm lino ritė, 500 m	3751,00 (3100,00)
		34255	8 mm lino ritė, 1 000 m	7381,00 (6100,00)
		34256	8 mm lino ritė, 1 500 m	11132,00 (9200,00)
		34257	8 mm lino ritė, reikiamo ilgio > 50 m, kaina už 1 m	Klausti pardavėjo

* Visi SafeLine komponentai pagaminti iš nerūdijančio plieno.

Profiliuoti lakštai

Sienoms ir stogui

Kaina €/m² su PVM 21% (€/m² be PVM)

Vaizdas	Pavadinimas	Ruukki® 50 Plus	Ruukki® 40	Ruukki® 30 Plus	Ruukki® 30
	T20-79-1100 (sienoms) T20-24-1100 (sienoms) T20-24W-1100 (stogui)	21,18 (17,50)	18,39 (15,20)	14,40 (11,90)	13,07 (10,80)
	T45-30W-905 (stogui)	28,62 (23,65)	23,60 (19,50)	22,02 (18,20)	20,21 (16,70)
	T20 su antikondensaciniu veltiniu *	27,13 (22,42)	24,34 (20,12)	20,35 (16,82)	19,02 (15,72)
	T45 su antikondensaciniu veltiniu *	34,57 (28,57)	29,55 (24,42)	27,98 (23,12)	26,16 (21,62)

* Antikondensacinis sluoksnis – vidinėje T20, T45 lakštų pusėje priklijuotas specialus Dripstop Original veltinis.

DripStop privalumai

- Geresnės akustinės savybės (-2dB)
- Degumo klasė A2 – s1, d0
- Sugeria iki 1000 g/m² kondensato

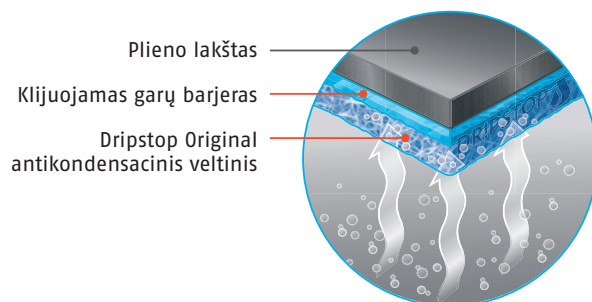

Ruukki® 50 Plus Matt kokybės klasės spalvos

Raudonos plytos (RR750)	Raudona (RR29)	Šokolado ruda (RR887)	Tamsi ruda (RR32)	Tamsi žalia (RR11)	Šviesi pilka (RR21)
Pilka (RR22)	Tamsi pilka (RR23)	Antracito (RR2H3)	Juoda (RR33)		

Ruukki® 30 kokybės klasės spalvos

Raudonos plytos (RR750)	Raudona (RR29)	Šokolado ruda (RR887)	Tamsi ruda (RR32)	Tamsi žalia (RR11)	Balta (RR20)
Šviesi pilka (RR21)	Pilka (RR22)	Tamsi pilka (RR23)	Antracito (RR2H3)	Juoda (RR33)	

Kaina €/m² su PVM 21% (€/m² be PVM)

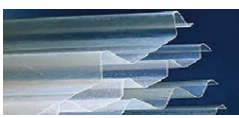
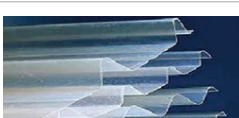
Vaizdas	Pavadinimas	Kodas	Pastabos
	Skaidrus lakštas T20-24W-1100 S	RA6T 5000 6903A1P20R	450 g/m ² 26,26 (21,70)
	Skaidrus lakštas T45-30W-905	RA6T 5000 69039145R	450 g/m ² 31,22 (25,80)

Profiliuoti lakštai

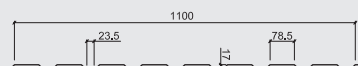
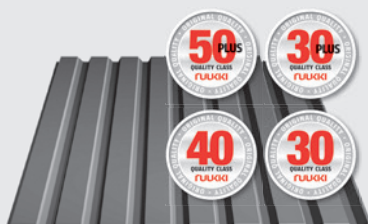

T20-79-1100

Naudingas dengiamas plotis	1100 mm
Profilio aukštis	17 mm
Bendras plotis	1140 mm
Minimalus ilgis	500 mm
Maksimalus ilgis	10 000 mm
Viršūnės plotis	79 mm
Minimalus stogo nuolydis	11°
Lakšto storis	0.50 mm
Cinko kiekis	275 g/m ²
Svoris	4.5 kg/m ²

✓ Galimybė užsakyti su antikondensaciniu veltiniu

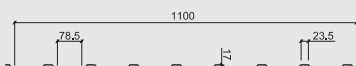
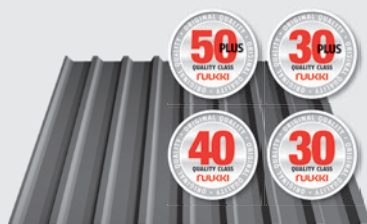

T20-24-1100

Naudingas dengiamas plotis	1100 mm
Profilio aukštis	17 mm
Bendras plotis	1140 mm
Minimalus ilgis	500 mm
Maksimalus ilgis	10 000 mm
Viršūnės plotis	24 mm
Minimalus stogo nuolydis	11°
Lakšto storis	0.50 mm
Cinko kiekis	275 g/m ²
Svoris	4.5 kg/m ²

✓ Galimybė užsakyti su antikondensaciniu veltiniu

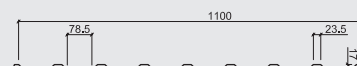
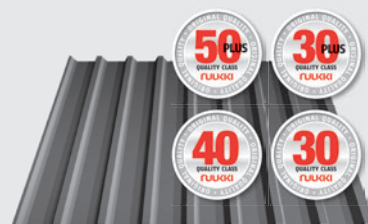

T20-24W-1100

Naudingas dengiamas plotis	1100 mm
Profilio aukštis	17 mm
Bendras plotis	1140 mm
Minimalus ilgis	500 mm
Maksimalus ilgis	10 000 mm
Viršūnės plotis	24 mm
Minimalus stogo nuolydis	11°
Lakšto storis	0.50 mm
Cinko kiekis	275 g/m ²
Svoris	4.5 kg/m ²

✓ Galimybė užsakyti su antikondensaciniu veltiniu



T45-60-905

Naudingas dengiamas plotis	905 mm
Profilio aukštis	44 mm
Bendras plotis	960 mm
Minimalus ilgis	500 mm
Maksimalus ilgis	10 000 mm
Viršūnės plotis	60 mm
Minimalus stogo nuolydis	11°
Lakšto storis	0.50 mm
Cinko kiekis	275 g/m ²
Svoris	5.42 kg/m ²

✓ Galimybė užsakyti su antikondensaciniu veltiniu

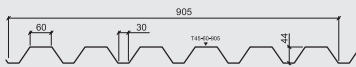
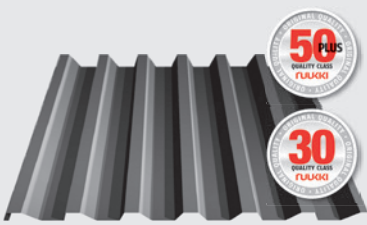

T45-30-905

Naudingas dengiamas plotis	905 mm
Profilio aukštis	44 mm
Bendras plotis	960 mm
Minimalus ilgis	500 mm
Maksimalus ilgis	10 000 mm
Viršūnės plotis	30 mm
Minimalus stogo nuolydis	11°
Lakšto storis	0.50 mm
Cinko kiekis	275 g/m ²
Svoris	5.42 kg/m ²

✓ Galimybė užsakyti su antikondensaciniu veltiniu



T45-30W-905

Naudingas dengiamas plotis	905 mm
Profilio aukštis	44 mm
Bendras plotis	960 mm
Minimalus ilgis	500 mm
Maksimalus ilgis	10 000 mm
Viršūnės plotis	30 mm
Minimalus stogo nuolydis	11°
Lakšto storis	0.50 mm
Cinko kiekis	275 g/m ²
Svoris	5.42 kg/m ²

✓ Galimybė užsakyti su antikondensaciniu veltiniu

Profilis stogo pakalimams Soffit

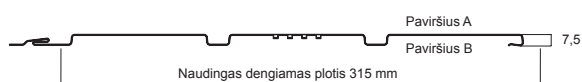
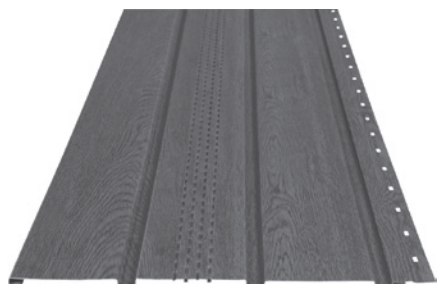

* Galima užsakyti reikalingų ilgių lakštus

Profilio aukštis	7,5 mm
Cinko kiekis	275 g/m ²
Minimalus ilgis	300 mm
Maksimalus ilgis	3 600 mm
Lakšto storis	0,5 mm
Naudingas dengiamas plotas	1,13 m ² /vnt.
Lakštų skaičius pakuotėje	44 vnt.

Kaina €/m² su PVM 21% (€/m² be PVM)

Pavadinimas	Medžio imitacija	Ruukki 30 Plus Matt	Ruukki 30
Soffit	28,07 (23,20)	24,50 (20,25)	23,29 (19,25)

Kaina €/vnt. su PVM 21% (€/vnt. be PVM)

Vaizdas	Pavadinimas	Kodas	Kokybės klasė	
	Startinis elementas "J"	305000418	Ruukki 30	9,08 (7,90)
	2000 mm		Ruukki 30 Plus Matt	9,56 (7,90)
			Medžio imitacija	10,83 (8,95)
	Vidinis kampas	30500039707	Ruukki 30	7,02 (5,80)
	Išorinis kampas	30500039807	Ruukki 30 Plus Matt	7,62 (6,30)
	2000 mm		Medžio imitacija	9,32 (7,70)
	Nerūdijančio plieno sraigčiai Classic tvirtinimui	RAS1WP4225PH2		8,83 (7,30)
	4.2 x 25 mm			
	100 vnt./pak., AiSi			

Galimos spalvos

Balta (RAL9010)	Šokoladinė (RR887)	Tamsiai pilka (RR23)	Antracito (RR2H3)	Juoda (RR33)	Ažuolo šviesi
--------------------	-----------------------	-------------------------	----------------------	-----------------	---------------

Lygi skarda

Kaina €/m² su PVM 21% (€/m² be PVM)

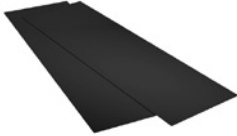
Vaizdas	Pavadinimas	Storis	Kokybės klasė, padengimas	
	Lygi skarda	0,50 mm	Ruukki® 50 Plus Matt	18,27 (15,10)
		0,50 mm	Ruukki® 40	16,09 (13,30)
		0,50 mm	Ruukki® 30 Plus Matt	11,68 (9,65)
		0,50 mm	Ruukki® 30	11,07 (9,15)
		0,50 mm	Zn	11,07 (9,15)
		0,60 mm	Ruukki® 50 Plus Matt	20,51 (16,95)

* Apsauginė plėvelė lygiai skardai + 0,48 (0,40) €/m²

Ruukki® 50 Plus Matt lygios skardos spalvos

Raudonos plytos (RR750)	Raudona (RR29)	Tamsi ruda (RR32)	Tamsi žalia (RR11)	Šviesi pilka (RR21)	Pilka (RR22)
Tamsi pilka (RR23)	Antracito (RR2H3)	Juoda (RR33)	Šokolado ruda (RR887)		

Ruukki® 40 lygios skardos spalvos

Raudona (RR29)	Tamsi ruda (RR32)	Tamsi pilka (RR23)	Antracito (RR2H3)	Juoda (RR33)	Šokolado ruda (RR887)
-------------------	----------------------	-----------------------	----------------------	-----------------	--------------------------

Ruukki® 30 Plus Matt lygios skardos spalvos

Raudona (RR29)	Tamsi ruda (RR32)	Tamsi pilka (RR23)	Antracito (RR2H3)	Juoda (RR33)	Šokolado ruda (RR887)
-------------------	----------------------	-----------------------	----------------------	-----------------	--------------------------

Ruukki® 30 lygios skardos spalvos

Raudonos plytos (RR750)	Raudona (RR29)	Tamsi ruda (RR32)	Tamsi žalia (RR11)	Balta (RR20)	Šviesi pilka (RR21)
Pilka (RR22)	Tamsi pilka (RR23)	Antracito (RR2H3)	Juoda (RR33)	Šokolado ruda (RR887)	

Lygi skarda TSP (plastiškas plienas)

Kaina €/vnt. su PVM 21% (€/vnt. be PVM)

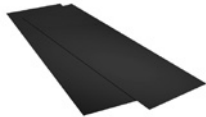









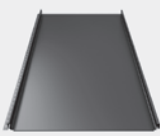
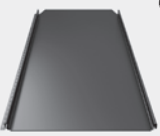
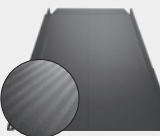
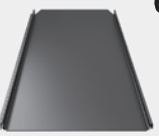
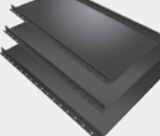
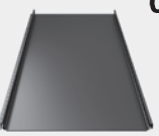
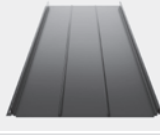

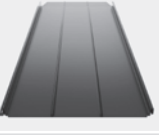
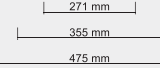

















































Vaizdas	Pavadinimas	Storis	Kokybės klasė	
	Lygi skarda	0,60 mm	Ruukki® 50 Plus Matt	22,69 (18,75)

Ruukki® 50 Plus Matt TSP lygios skardos spalvos

Raudona (RR29)	Tamsi ruda (RR32)	Šviesi pilka (RR21)	Tamsi pilka (RR23)	Antracito (RR2H3)
-------------------	----------------------	------------------------	-----------------------	----------------------

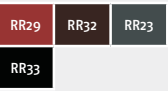
Bendra Classic profilių savybių palyginimo lentelė

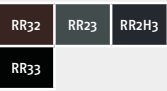
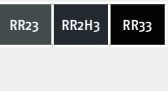

	NAUJIENA					
	Classic Economy Plus	Classic C/D	Classic M	Classic Authentic	Classic Design C	Classic NextGen
	 C	 C	 M	 C	 C	 C
	 D	 D		 D		
						
Kokybės klasė	Ruukki® 30 Plus	Ruukki® 50 Plus	Ruukki® 50 Plus	Ruukki® 50 Plus	Ruukki® 50 Plus	Ruukki® 50 Plus
Atsparumas UV spinduliams						
Atsparumas įbrėžimams						
Paviršiaus polimerinis padengimas	matinis	matinis	matinis	matinis	matinis	matinis
Garantija (techninė/estetinė)	30/10 metų	50/25 metų	50/25 metų	50/25 metų	50/25 metų	50/25 metų
Priekinio krašto užlenkimas						
Uždengiami valcų galai						
Mikroprofiluota tvirtinimo linija						
Bet kuri montavimo kryptis						
NAUJIENA						
Lakšto storis 0,60 mm						
Mikroprofiluotas lakštas						
Akustinis veltinis						
	* užsakant Silence	* užsakant Silence	* užsakant Silence	* užsakant Silence		
Sujungimų sandarumą padidinanti tarpinė						
Spalvos						

Ruukki Construction yra plieninių, stogams ir sienoms skirtų statybos produktų ir paslaugų tiekėja tvariems pastatams. Kurdami produktus tvirtai laikomės tvarumo, ilgaamžiškumo vertybinių nuostatų, esame sukaupę ilgalaikę patirtį plieno ir statybų pramonės srityse.

Gotinga

VISKAS
JŪSŲ STOGUI

RUUKKI

VELUX®

VILPE®

Tyvek®

- Stogų ir sienų dangą, bei komplektuojančias detales ir medžiagas;
- Lietaus nuvedimo sistemas;
- Įvairias statybines plėveles;
- Konsultuoja montavimo klausimais.

Demokratų g. 3, LT-48427 Kaunas

Tel./faksas +370 37 361 612

mob. +370 698 74656

info@gotinga.lt

www.gotinga.lt

www.dengiustoga.lt

RUUKKI

Centrinis biuras Pramonės g. 16, Vaidotai, 14149 Vilniaus raj.
tel. (5) 232 23 15 ruukki.lietuva@ruukki.com

Kauno skyrius Partizanų g. 63M, 50300 Kaunas
tel. (37) 32 74 07 kaunas@ruukki.com

Klaipėdos skyrius Svajonės g. 38, 94101 Klaipėda
tel. (46) 49 25 49 klaipeda@ruukki.com

Panevėžio skyrius S. Kerbedžio g. 7A, 35104 Panevėžys
tel. (45) 46 30 47 panevezys@ruukki.com

Šiaulių skyrius Metalistų g. 8F, 78136 Šiauliai
tel. (41) 52 00 80 šiauliai@ruukki.com

Ruukki Products AS

www.ruukki.lt

www.ruukkistogas.lt

